

# DEFENSIBLE DESIGN IN RESIDENTIAL URBAN ARCHITECTURE

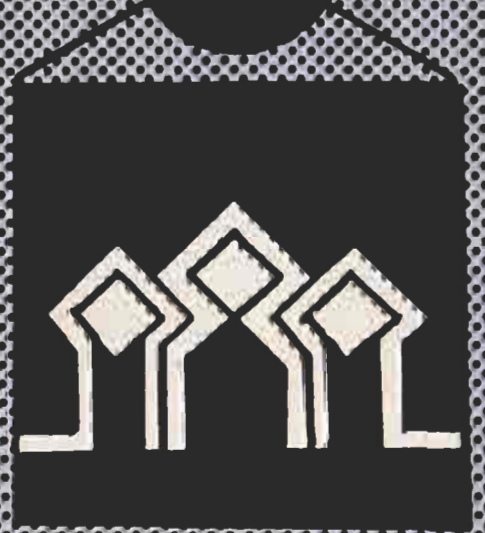

PUBLISHING HOUSE

## ARAB SECURITY STUDIES AND TRAINING CENTER IN RIYAD

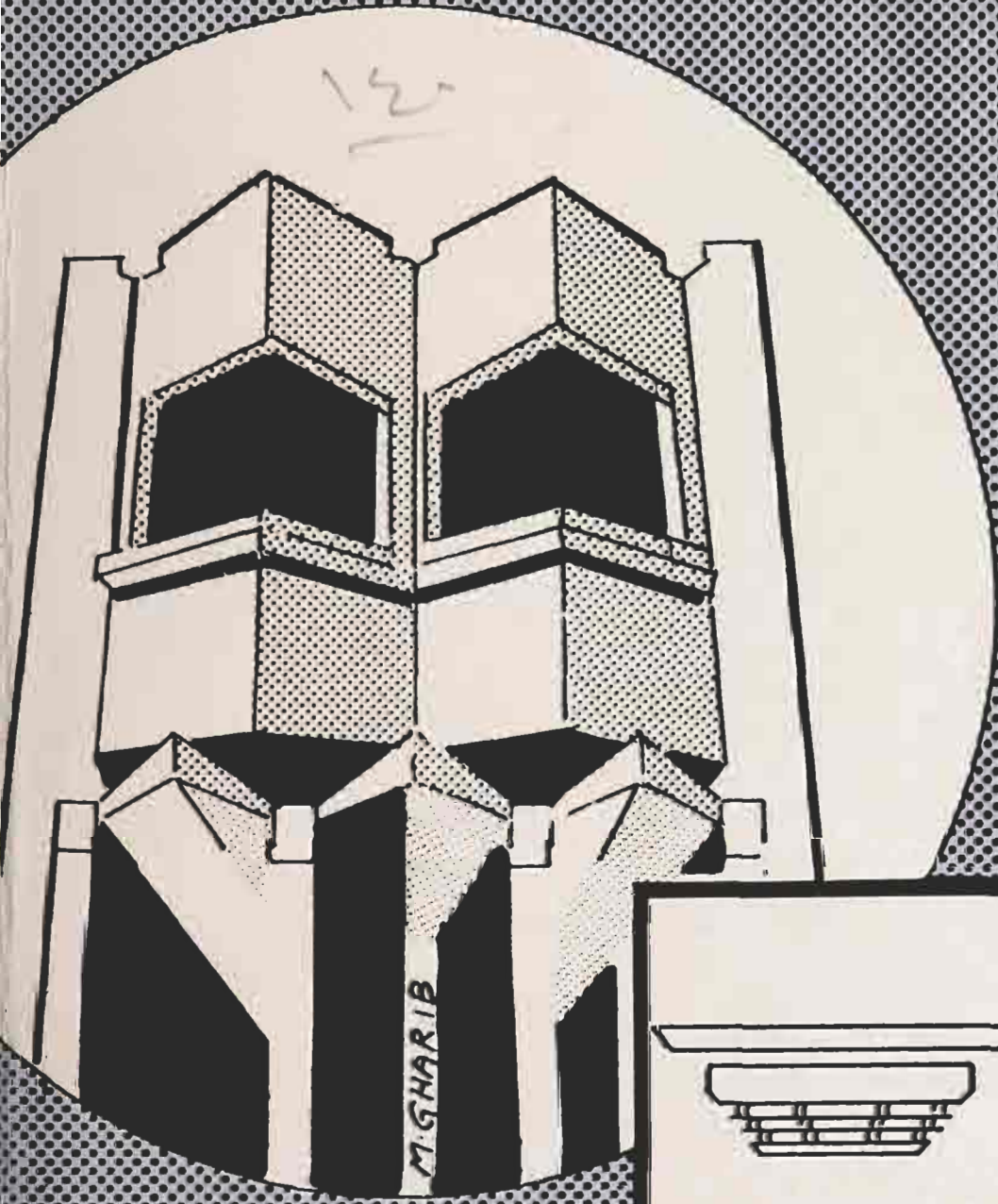
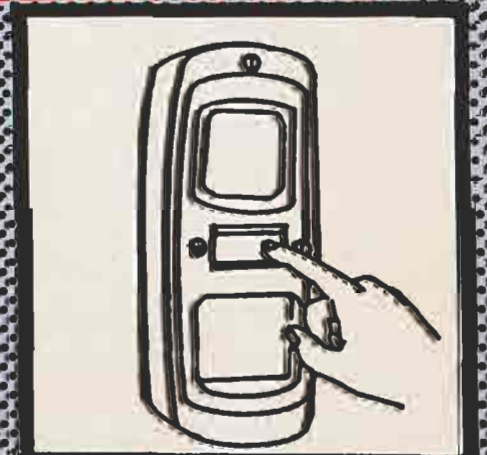



مكتبة جامعة القاهرة للعلوم الأمنية

# إدارة المطابع

نسخة الأرشيف

الرقم ٤ / ٢٤ التاريخ ١٩٨٤



# **DEFENSIBLE DESIGN IN RESIDENTIAL URBAN ARCHITECTURE**

**DR. ELLAHI ISHTEEAQUE**

**PUBLISHING HOUSE  
ARAB SECURITY STUDIES AND TRAINING CENTER IN RIYAD  
1993**



## **CONTENTS**

- Foreword .....	by Dr. Farouk A. Murad .....	9
- Preface .....		11
- Introduction .....		13
- Defining Crime .....		19
- A Scenario on Arab Housing Patterns .....		21
- Defensible Space .....		28
- Individual Single Family Houses .....		39
- Multi-Family Houses .....		53
- A New Approach: Security Code .....		74
- Case Study: Crash Housing Project at Dammam .....		85
- Bibliography .....		99



## **FOREWORD**

**The Arab Security Studies and Training Center have been calling since it was established in 1980, for taking in consideration the Security Factors in architectural design and city planning in general. The past ten years or so have proved beyond any doubt the importance of security of individual homes, residential compounds and buildings, commercial and official buildings. Urban security has jumped to the forefront of the concern of government and business as well as individual residents of urban centers, practically every where in the world.**

**This book was written by a professor who possesses deep insight in the security and safety of people. It will contribute to this new and developing subject specially in the Arab region, written in English, it will have much wider circulation and will add considerably to a limited but growing body of knowledge on what is called Defensible Space although it was not intended to be a manual for security of buildings, however the Center's Consultative Office have used much of the application presented in the volume in the services it provided to many security-minded organizations. We expect other consultants and architects as well as city and urban planners will find the book of considerable value. This book is one of few in its subject published in the region and this is a vital contribution to the specialized library.**

**FAROUK A. MURAD**





## **PREFACE**

In the Western World crime rates have shown alarming increase in the last two decades; in contrast the countries in the Arab World enjoy peace and have much lower rate of criminal offences. It is true that Arab countries are relatively safe from offenders but the current growth related to oil and oil economy and the social transformations occurring at all quarters, because of fast growing economy, along with the great influx of foreign nationals of varied cultures is liable to imprint some lasting changes. Such changes and their aftereffects is the area of concern by social scientists, architects, planners and security personnel.

When The Arab Security Studies and Training Center requested me to conduct research and write this book on crime prevention in residential areas, I found it extremely difficult to find a point of beginning. This difficulty was justly based on very limited or no data available on the subject, no real sources of information, limited accessibility, and specially an extremely short time frame of about two months. In the early stages even the title of this study was undefined and unclear but as I looked deeper and progressed in the research, it was realized that we are dealing with defensible design and social defense. It was felt that there is an urgent need to understand the conditions which foster crime and at the same time those conditions needed to come about in the design process which helps prevent crime.

The various segments of this book explain and illustrate above said conditions and draw general conclu-

sions from an actual case study and stipulates the need for a security code.

I am greatly thankful to H.E. BAKRI SHATA, Assistant Deputy Minister for the Ministry of Public Works and Housing and his office for supplyig much needed information on Crash Housing Project in Dammam. I also express my appreciation to Dr. Farouk A. Murad for the opportunity to publish this study and continued encouragement.

Special thanks are due to numerous criminal justice planning agencies, various offices of Chiefs of Police and Sherriffs and security hardware manufacturers in U.S.A.

Lastly, it would not have been possible to conduct this study without the consent and agreement of Dr. Zamil Mokrin, Dean, College of Environmental Design, U.P.M. Dhahran.

# INTRODUCTION

This publication is based on a study of the forms of our residential areas and how they contribute to our victimization by criminals and offenders. It also broadly examines how environments affect behavior. Suggestive measures and recommendations for the design of urban residential areas are made here to produce a safe and secure living environment.

Historically, security and social defense have been quite low on the architect's list of priorities, with subjects such as aesthetics, construction costs and new technologies being among those deemed much more important. In fact, some architects consider security as anathema, seeing it as restricting their freedom of design. Yet, security is a functional element of design which should not be neglected if competent professional services are to be provided.<sup>(1)</sup>

Based on my own active professional and architectural experience of more than 15 years, I am aware that most architects and social planners are ignorant on the general subject of defense in the design of their projects. It is oftenly left to the initiative of clients to suggest the need for security provisions that might be required or desired.

This study is meant to benefit general public and educate people about safeguarding their houses from offenders, and building conditions for their safety. In the

---

1 - Handbook of building security planning and design by Peter S. Hopf. 1979.

whole Arab World, the question of security should be addressed in at least two specific directions. First safety conditions guarding residents from local offenders. Second, the presence of a very large multi-national expatriate community poses special problems. Their housing needs, social needs, recreational demands and type and extent of interface with natives require very special attention. Fulfilling these needs of the expatriates is a great social responsibility for the host countries.

### **Background**

During the twentieth century, great strides have been made in unveiling the mysteries of the universe and discovering the laws of nature, and its newly acquired knowledge has been put to both constructive and destructive use by man. (1)

Scientific and technological progress is concentrated on the material aspects, ignoring the social and human viewpoints. Consequently, these later lagged behind and the gap between the material and moral aspects has widened, thus creating a feeling of restlessness and instability. Man has therefore failed to organize constructive social relationships that could secure order and social equity. (2)

Conservative societies enjoyed a social organization

---

1 Effect of the implementation of the Islamic legislation on Crime Prevention in the Kingdom of Saudi Arabia by Dr. Farouk Murad Proceedings of symposium held in Riyadh Oct. 9-13, 1976.

2 - Ibid



commensurate with the requirements and material ambitions of their members, but once these societies came under the influence of modern material civilization their members were carried away by its social philosophy and system, and thereby suffered from deprivation of social and human values. <sup>(1)</sup>

Present day societies are suffering from social deterioration and the crime rate is now measured in hours and minutes. Tremendous resources, both material and human, are drained to combat the spread of crime. <sup>(2)</sup>

### **Peaceful Land**

Amid a world tormented by social problems, in particular the disintegration of the family as a social unit, poor upbringing, delinquency, perversions, economic crises, corruption of local governments and the widespread use of drugs and alcohol, the Arab countries emerge very peaceful. Crime rate was never high in the Arab World due to the implementation of the Shari'a. For example in Saudi Arabia the application of Qisas punishment and hand amputation has remarkably deterred offenders. Accurate statistics on crimes such as murder and maiming were not available before, but now they are being collected and processed using modern methodology. Lack of statistics poses a serious problem for researchers, so Arab countries are urged to lay special emphasis on conducting criminal statistics.

---

1 - Ibid

2 - Ibid

When asked about the numerous aliens who reside in the Kingdom, the reply is that they should know beforehand of the conditions here and they must abide by the teachings of the Shari'a. In conclusion, there are two brief remarks:

**First:** Those who come here to work know quite well that for the sake of their own livelihood they must not do anything contradictory to the Shari'a. (2)

**Second:** Temptations are limited in Saudi Arabian society, for example, prohibition has minimized the occurrence of alcohol consumption; chastity, which characterizes the Muslim Saudi woman, dissuades sexual offences which are common in other countries. (1)

The tables on the following pages show crime rate in Saudi Arabia and other countries. At comparing these tables a base understanding can be achieved on various crimes and offences.

We should not be misled by this information as there are no data available regarding industrialization and urban growth to enable us to discover their relationship with the crime rate and therefore the apparent low rate cannot be ascribed to these.

---

1 - Dr Hassan Saaty Section 4 Proceedings of Symposium held in Riyadh Oct 9-13, 1976, published by Crime Prevention Research Centre, Ministry of Interior, Saudi Arabia.

*Crime Rate in the Kingdom over Ten Years (Years in A.H.)*

Year	Population	Number of Crimes	Rate per 1,000 Inhabitants
1386 (1966)	5 662 000	1850	32
1387	5 815 000	1670	28
1388	5 973 000	1377	23
1389	6 135 000	1229	20
1390	6 301 000	1401	33
1391	6 472 000	1234	19
1392	6 647 000	1424	22
1393	6 827 000	1376	20
1394	7 012 000	1370	19
1395	7 201 000	1304	18

Source: Statement attached to the Minister of Treasury letter No. 32 dated 16/8/1396 H.

*Rate of Murder in the Kingdom over Ten Years per thousand of the Population*

Year	Number of Murders	Rate per 1,000 Inhabitants
1386 (1966)	169	03
1387	154	03
1388	74	01
1389	40	01
1390	49	01
1391	41	01
1392	54	01
1393	39	01
1394	54	01
1395	70	01

SOURCE: Statistics Dept: Ministry of Interior, Interior; Saudi Arabia July 29, 1979

**Crime Rate Per Thousand of the Population.**

Country	Population	Number of Crimes	Rate Per Thousand	Year
Spain	15 519 899	112 700	7.26	1972
Australia	12 728 461	307 360	75.00	1971
Federal Republic of Germany	6 167 350	2 572 530	41.71	1972
Indonesia	123 000 000	181 407	1.47	1972
Italy	54 642 318	1 136 808	20.08	1972
Bahrain	200 000	7 479	37.393	1972
Tunisia	520 000	41 633	8.00	1972
Denmark	4 975 653	301 142	60.52	1972
Rumania	21 000 000	16 858	5.08	1972
Sudan	1 700 000	42 444	2.50	1972
Ghana	9 000 000	96 505	10.72	1972
France	51 914 600	1 675 507	32.27	1972
Venezuela	11 300 000	77 628	6.86	1972
Finland	4 598 000	292 084	63.52	1972
Canada	21 984 000	1 648 817	75.00	1972
Korea	33 167 000	412 137	12.42	1972
Kuwait	800 000	9 983	12.48	1972
Kenya	12 067 000	57 229	4.74	1972
Lebanon	2 500 000	1 121 972	448.77	1972
Libya	2 257 037	6 780	3.00	1972
Mali	5 000 000	1 661	0.33	1972
Morocco	17 109 133	70 013	4.90	1972
Japan	107 300 000	1 396 032	13.00	1972

Source : International Criminal Police Organization, Interpol International Crime Statistics 1971-72.

## **DEFINING CRIME**

### **Crime according to the Islamic Legislative Sources.**

Crime in Islam, is the commission of a prohibited act or the omission of a commandment as ordered or forbidden by God and His Prophet. God has prescribed appropriate penalties for the crime perpetrated. This is done in accordance with the injunctions of the Quran which specifies the types of the penalty to be inflicted. In Islamic Jurisprudence crimes are classified according to the extent of the damage done. In the Islamic Shari'a penalty is characterized by the fact that only the offender is held responsible and punished, offenders committing the same crime get the same punishment, and no punishment can be inflicted unless verified by the Quran or the Hadith. Sources of the Islamic Criminal Legislation are the Holy Quran, Sunnah, Imams, Consensus of Opinions, Analogy, Universally approved opinions and Unspecified Interest of Common Good. The penalties related to Hudoud and all forms of assaults are determined by the relevant Quranic verses, and those prescribed for other crimes are determined in accordance with other sources. The flexibility which characterizes the Islamic criminal jurisprudence enables it to cope with any type of crime. (1)

The Islamic criminal legislation leaves no room for the offender to escape punishment. Penalty in the Shari'a is a deterrent and repellent at the same time. The Islamic

---

1 Final report Proceeding of Symposium held in Riyadh Oct 9-13, 1976, published by Crime Prevention Research Center, Ministry of Interior, Saudi Arabia.



Shari'a is anxious to preserve the five fundamentals of society, namely; religion, life, offspring, property and intellect. <sup>(1)</sup>

## **CRIMINAL RESPONSIBILITY ACCORDING TO ISLA- MIC LEGISLATION**

Criminal responsibility is based on moral grounds more so than on abstract laws. Punishable crimes are also sins forbidden by religion, and therefore, avoiding a sin is not only compliance with the written commandment/ but it is also a sign of submission to God. Thus everybody is responsible for his own behavior as the Quran says: "No soul shall bear another's burden". Islam leaves the way open for the offender to repent so that he will not be stigmatized because of his crime, and after penalization he can return to society as a useful citizen.

---

1 - Ibid

## **A SCENARIO ON ARAB HOUSING PATTERN**

**In the Arab World, historically, many factors influenced the traditional house and living pattern in the rural setting or in an urban fabric of a city. These factors include Religious, Climatic, Political and Social conditions. In this study emphasis is only laid on social conditions which generated the needs for privacy, segregation, and elements of security.**

**All houses and even cities at large are contained within the walls which clearly indicate that a physical barrier has been placed between the interior and exterior forces to achieve peaceful living conditions and each citizen and every member of the society should respect the existence of this barrier. Those who violate the laws and conditions of the society will be prosecuted accordingly.**

**In an Arab city the Rules of Islam have influenced the social life of the people. Within the walls surrounding the quarters, houses were built to satisfy the increase of population. As the individual members of the family became financially independent, the traditional social and economic structure transformed. New members of the society built houses for new nuclear families; and these houses carried the same principles that the previous houses had.**

**The conditions of privacy plays a major role in Muslim life, and because of it, an urban dweller clearly separates his secluded, private house-life from external communal intercourse. This means that the citizen has in fact a double, clearly balanced concern; private and public life.**

The dual quality of urban existence, coupled with the supreme importance given to religion, are the fundamental factors which precipitated the characteristic physiognomy

The strong need and desire for privacy and security dictated that the basic format of the dwelling unit be a confined area, hermetically closed to the exterior, which in turn generated the concentration of domestic life in and around the courtyard. This concept and practice represents the assimilation of both ancient mid-Eastern and Eastern Mediterranean sources, clearly integrated and wisely adapted to Islamic physical and cultural needs. Combining the walled gardens of ancient Persia with the Hellenistic peristyle the Middle East created a new type of setting; inside of which one could enjoy the pleasures of life in the open air and in strict seclusion. The same wish to attain, and what is more, to maintain privacy and social defense, dictated that the Arab dwelling be disguised to the outsiders. The individual walking through the winding streets of an Arab City, filled with jutting angles, narrow passages, and covered alleys, does not easily identify the walls of a rich mansion from those of a humble house. Everything in the city is imbricated, mixed and interpolated in such a way as to produce an effective architectural camouflage. An urban existence of this type entirely secluded and reacting against exterior manifestations, motivated the Arab City to be one without "Facade" inwardly oriented, a characteristic which is diametrically opposed to the Western City, where exterior display and facade exposure is a major concern.

The elements controlling the physical organization of

the Arab urban structure are based on the concept of growth from interior to exterior, i.e. from the house (interior) to the streets (exterior). The present day concept of the "street" has its double function firstly as an artery of traffic and secondly as a zone of major social/ communal intercourse. But this concept is primarily non-existent in the Arab City. In an Arab City the house has been the prevailing urban structure, an element which has forced the traffic lanes to conform to it. That is precisely what created a network of labyrinths in cities. Such organization is more vital, functional, and human than the one prevalent in the Western Cities, where the street becomes a supreme symbol of communal order to which the independence of the individual citizen has to be subordinated.

### **TRADITIONAL HOUSE**

The traditional architectural style of houses grew out of the several factors:

- ☆ Sociological circumstances (need for privacy).
- ☆ Desire for protection against external elements.
- ☆ Tradition of religion and worship.
- ☆ Patterns of life.
- ☆ Commerce.

While these considerations were weighted together to produce a style, the dimensions of the habitat were dictated largely by the physical space needs and the availability of building materials. Over the years surface changes were made, but behind changes in appearance the inner functions and design of housing remained unchanged.

**LEGEND**

- 1. ENTRANCE
- 2. BATH
- 3. KITCHEN
- 4. HAREM-LADIES ROOM
- 5. STORE
- 6. ROOM
- 7. COURTYARD
- 8. IWAN
- 9. FRIENDS' ROOM
- 10. ROOF TERRACE

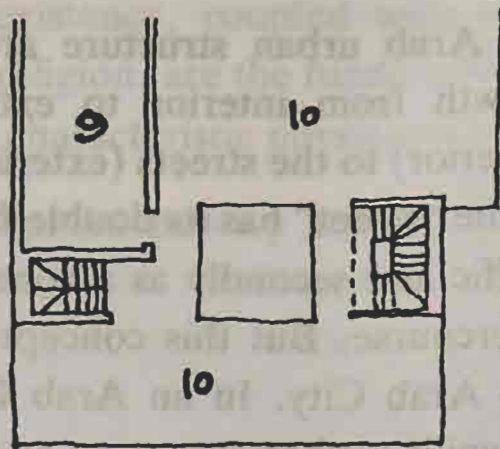

**THIRD FLOOR**

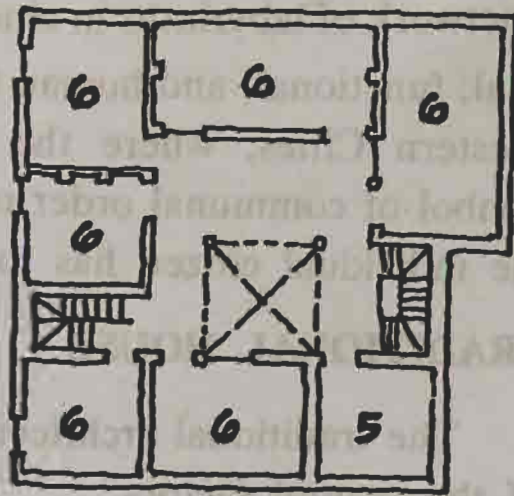

**SECOND FLOOR**

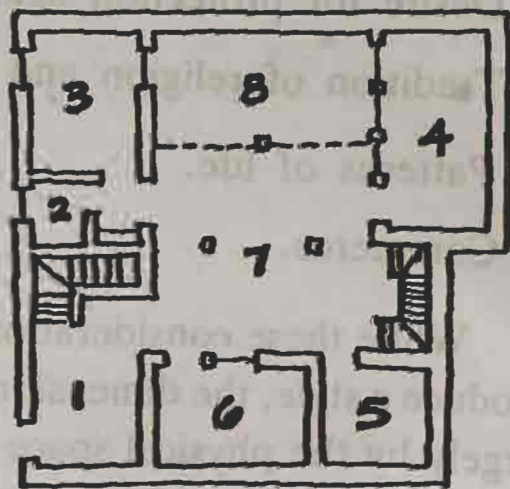

**FIRST FLOOR**

**TRADITIONAL HOUSE 2**



## **GENERAL EVOLUTION OF DWELLINGS**

Following six diagrams on next two pages typify a gradual evolution of present day dwellings from their historical counterparts based on changes occurring in site planning and site organization. Numbers given below refer to numbers given under each diagram.

- 1 - The houses were massed together and connected in groups each opening onto a patio or interior courtyard. Pedestrian traffic ways or other streets were introduced in this conglomeration when and where needed.
- 2 - The house blocks were cut down in size and volume and more new roads, streets were built. Houses still opened onto the courtyards.
- 3 - With the advent of new linear roadway system, houses started making a street facade. Thus windows on the exterior side of the buildings were introduced and dwelling design took the first step contrary to the built-in security found in a traditional courtyard house.
- 4 - As more roads and streets were cut, more or less according to a plan, each house had more than one elevation facing the street and usually these exterior walls had windows.
- 5 - A new era of construction was introduced with the building of individual houses, each on a separate parcel of land surrounded by a wall. The patio or courtyard was discontinued and the houses started having openings on all sides.
- 6 - For some communities, the individual houses were grouped and surrounded by a fence or wall, thereby

separating each community from the neighboring ones.



1

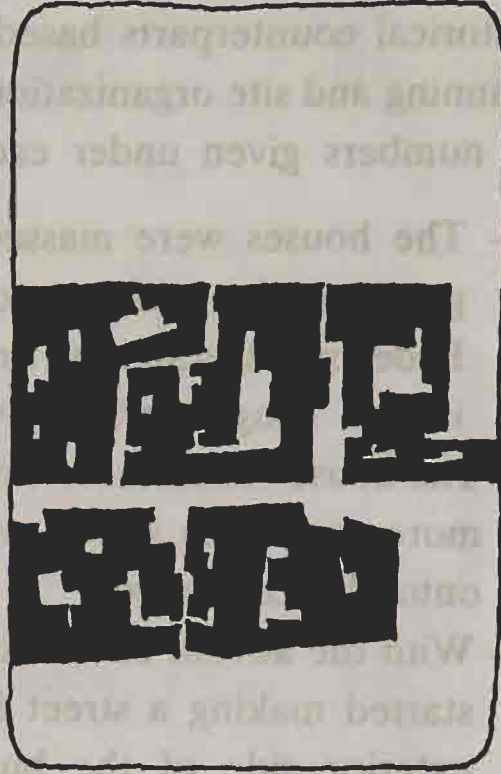

2

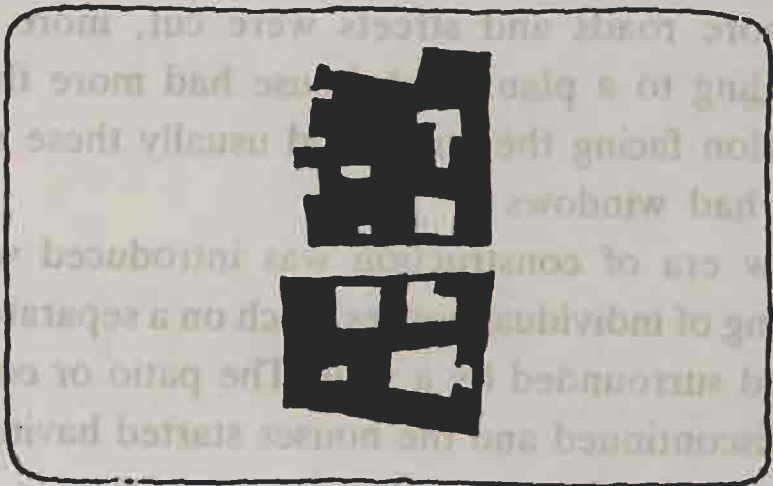

3

GENERAL EVOLUTION OF DWELLING 4

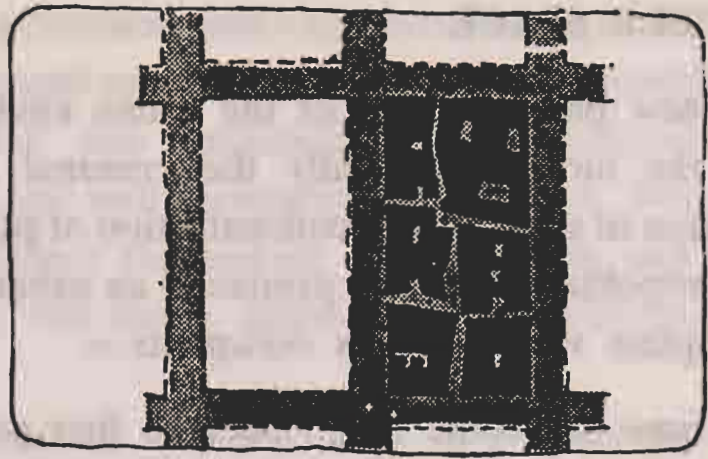

4

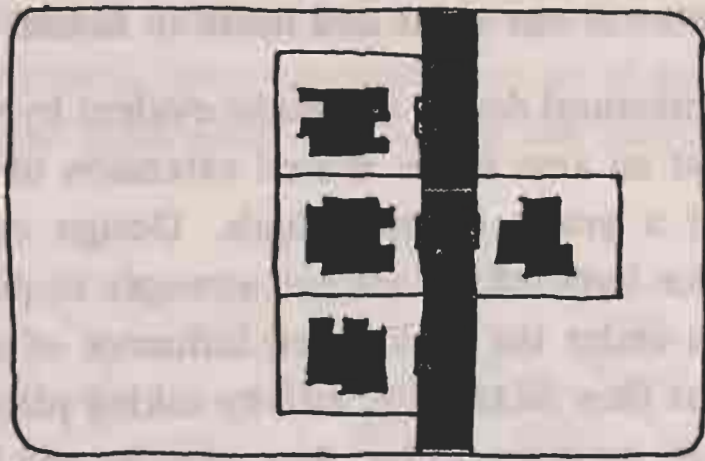

5

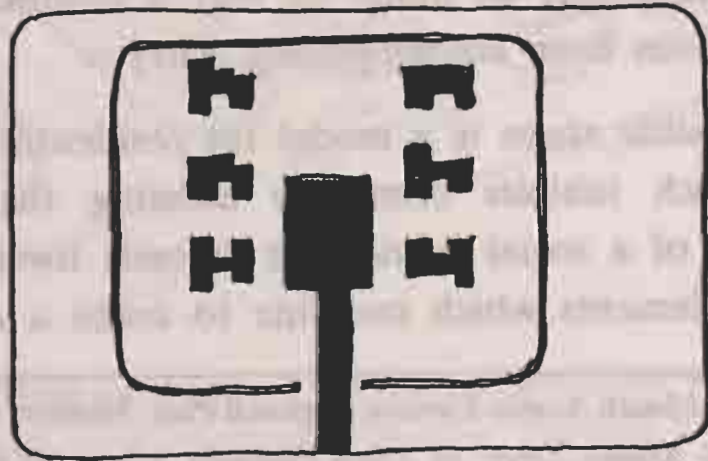

6

**GENERAL EVOLUTION OF DWELLING 5**

## **DEFENSIBLE SPACE**

The new physical form of the urban environment is possibly the most cogent ally the criminal has in his victimization of society. The concentration of population in large metropolitan areas has produced an urban form that makes hapless victims of its occupants. (1)

The time has come to go back to first principles to re-examine human habitat as it has evolved, to become attuned again to all the subtle devices invented over time and forgotten in our need and haste to house the many. (2)

Architectural design can make evident by the physical layout that an area is the shared extension of the private realms of a group of individuals. Design can make it possible for both inhabitant and stranger to perceive that an area is under the undisputed influence of a particular group, that they dictate the activity taking place within it, and who its users are to be. Any intruder will be made to anticipate that his presence will be under question and open to challenge; so much so that a criminal can be deterred from even contemplating entry. (3)

Defensible space is a model for residential environments which inhibits crime by creating the physical expression of a social fabric that defends itself. All the different elements which combine to make a defensible

---

1 - Kingdom of Saudi Arabia Eastern Regional Plan, Ministry of Municipal and Rural Affairs; Dept. of Town Planning Affairs by G. Candillis-Metra International Consultants - 1976.

2 - Ibid

3 - Ibid

space have a common goal - an environment in which latent territoriality and sense of community in the inhabitants can be translated into responsibility for ensuring a safe, productive, and well-maintained living space. When people begin to protect themselves as individuals and not as a community, the battle against crime is effectively lost.<sup>(1)</sup>

The form of buildings and their arrangement can either discourage or encourage people to take an active part in policing while they go about their daily business. The public areas of a multi-family residential environment devoid of defensible space can make the act of going from street to house equivalent to running the gauntlet.<sup>(2)</sup>

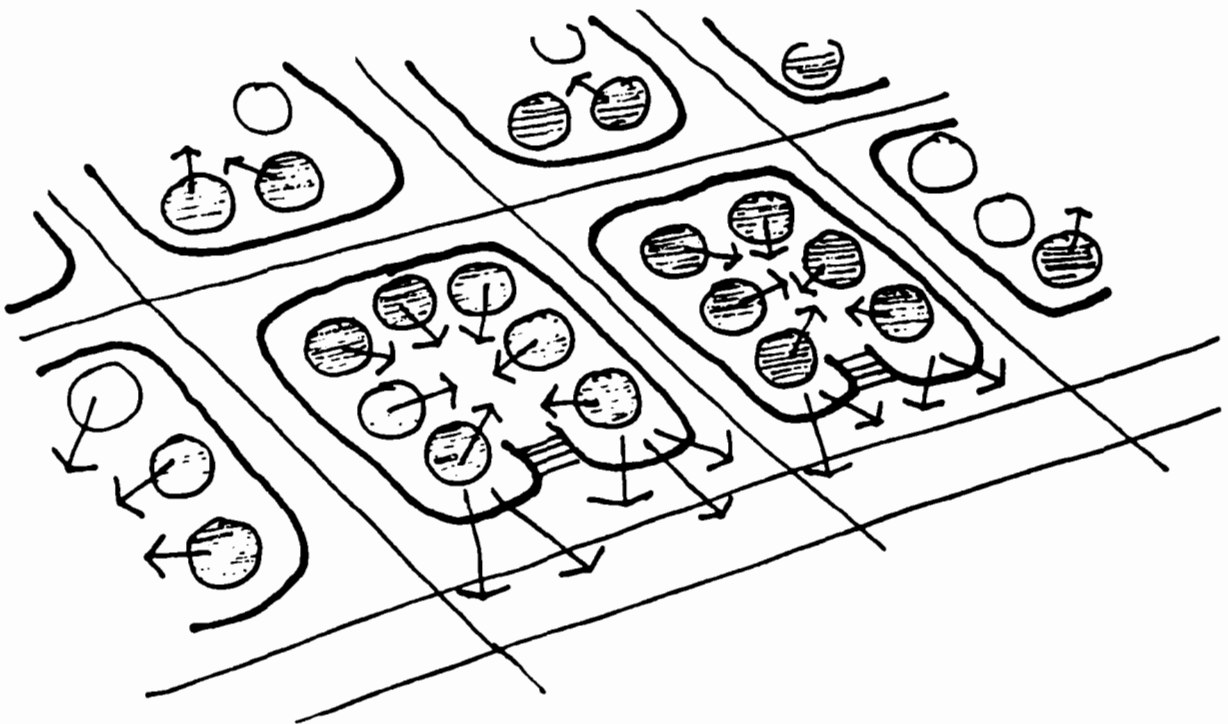

Fig. Sketch illustrating territorial definition: reinforced with surveillance opportunities (arrows).<sup>6</sup>

---

1 Ibid

2 Ibid

A criminal will rarely commit a crime in building in which he knows he will be easily recognized. Design can facilitate the process of recognition.

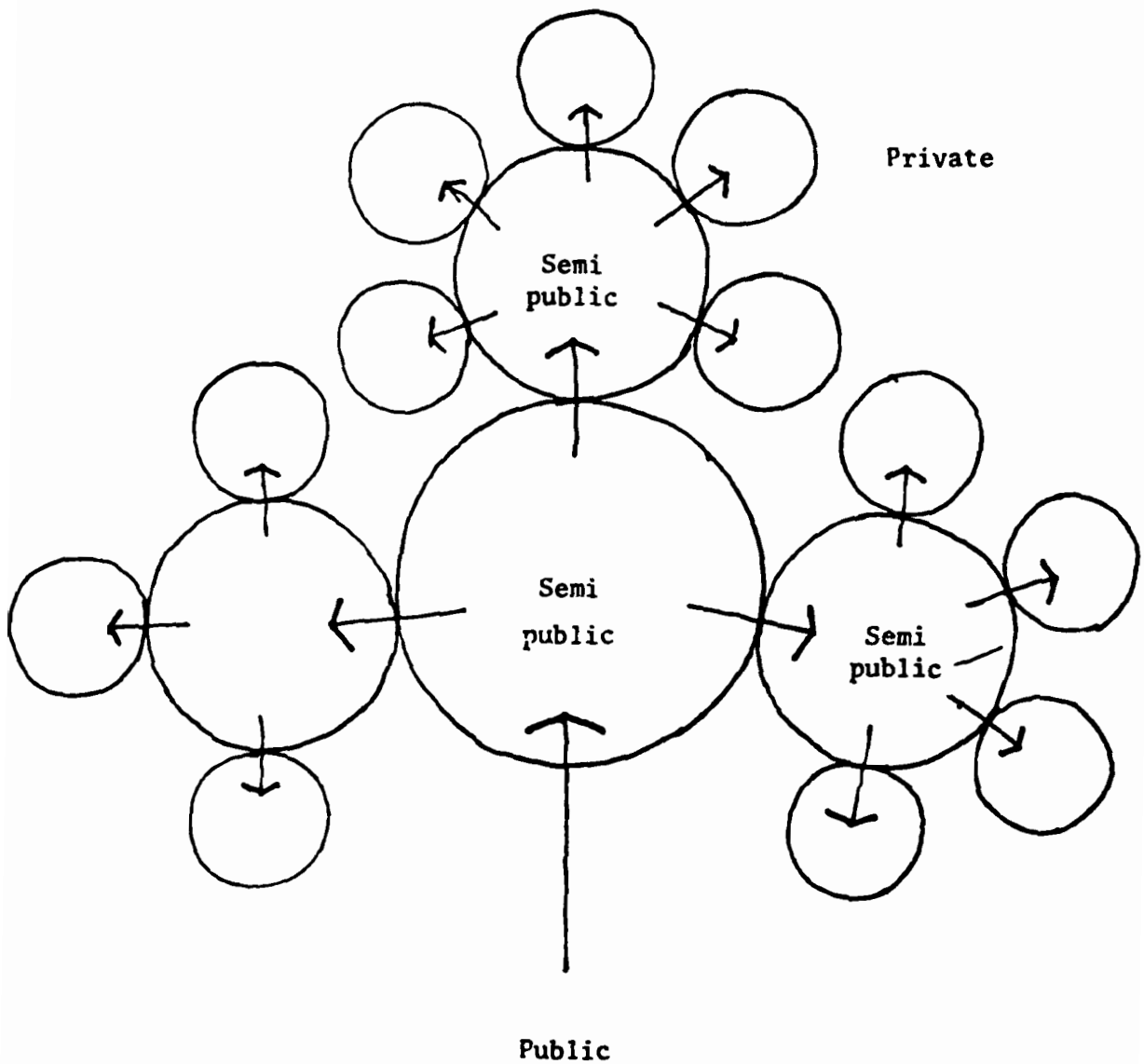
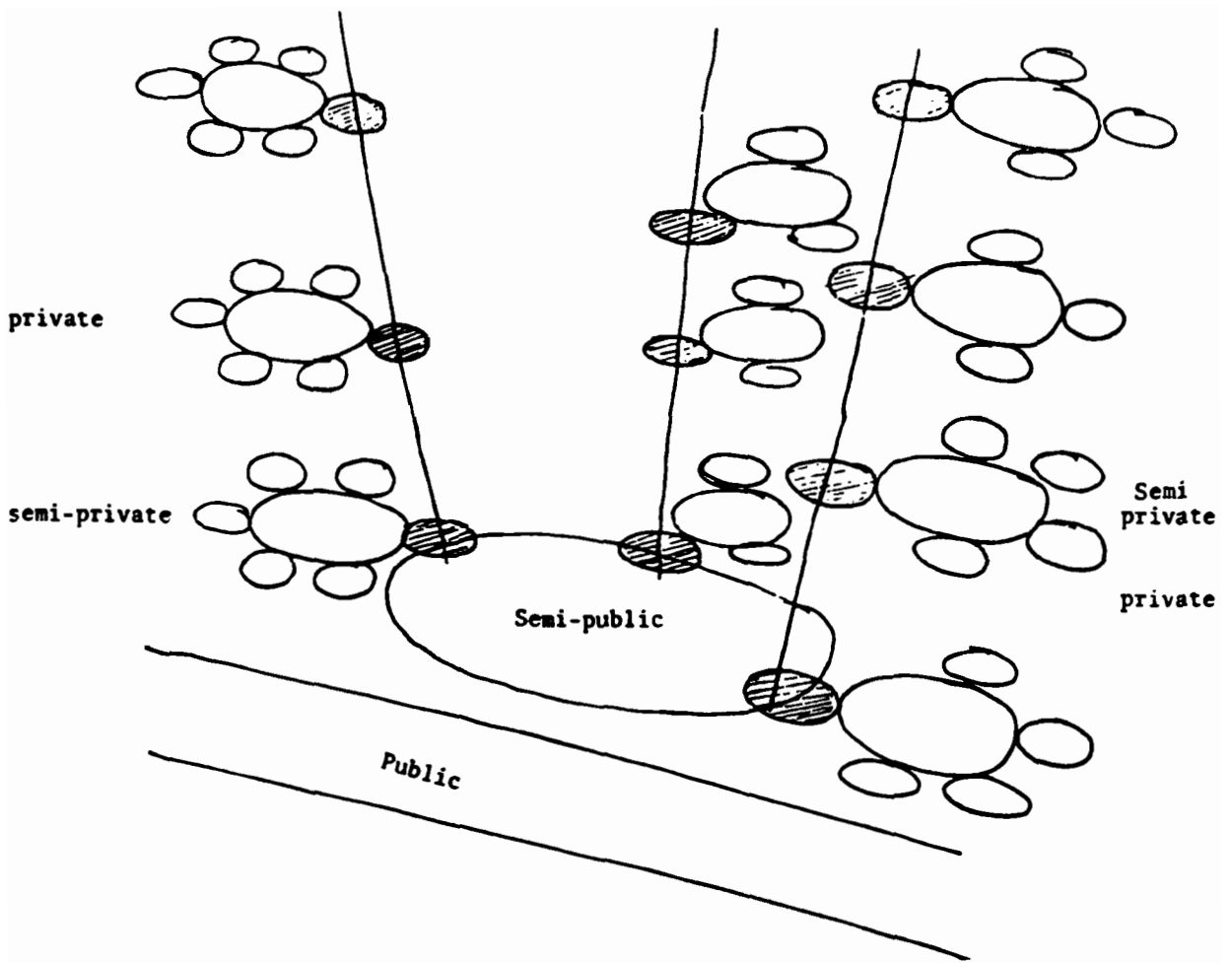

Fig. Heirarchy of Defensible Space: from public to private, arrow indicate entries at different levels of the heirarchy.<sup>7</sup>



Space heirarchy in multi-level units

Fig. Heirarchy of Defensible Space: from public to private, arrows indicate entries at different levels of the heirarchy.<sup>8</sup>

## **ELEMENTS IN DESIGN & PLANNING**

For years there has been a resistance to mixed uses in residential areas, i.e. to having commercial and industrial activities in residential areas and vice versa. The common assumption is that the most profitable and best land use is a single-family detached residence on an individual lot. The introduction of commercial facilities and apartments is seen as bringing in undesirable transient people. Increased density and a mixture of uses do attract more people and quite frequently do lead to anonymity or a lesser sense of community. On the other hand in a defensible environment, presence of people as observers tends to create a system of informal surveillance.

In a typical urban block the physical arrangement of buildings and alleys can provide ideal escape routes and hiding places, both of which can increase the probability of crime. Lighting, of course, has tended to reduce crime in urban areas.

## **CRIME INFORMATION**

Architects would never design a building in an area of questionable soils with test borings for the soils and geological analysis. When it comes to security against crime, seldom "Test borings" of the social conditions in the neighborhood are taken. Excellent records available with local police authorities are accessible to the public and for the design of project records on street crime, robbery, vandalism, rape etc. should be considered. Armed with such information, we can assess design implication for the project.



## **NEW CONCEPT**

The idea of crime prevention through environmental design (CPTED) is new. CPTED deals with three factors to reduce crime:

- 1 - Physical facilities
- 2 - Police force and services
- 3 - User characteristics and behavior.

In residential areas the key idea is to establish a sense of territoriality on both the neighborhood level and dwelling-unit level. In an individual building, the physical arrangement can either encourage feelings of community and natural surveillance or hamper these positive forces of crime reduction. Oscar Newman's work provides striking evidence as to the importance of the physical setting in reducing crime.

## **CRIME AND THE NEED FOR PROTECTION**

A quick look of crime statistics from California in 1974, which are generally true for the entire U.S. and could also be reviewed by fast developing countries as a factor for future demands of security, indicates that 15.9% are crimes against persons and 84.1% are property crimes (See Fig.). It can be seen that the burglary represents 53.7% of the major offences. The patterns of crime are changing, and crime is increasingly being committed by juveniles.

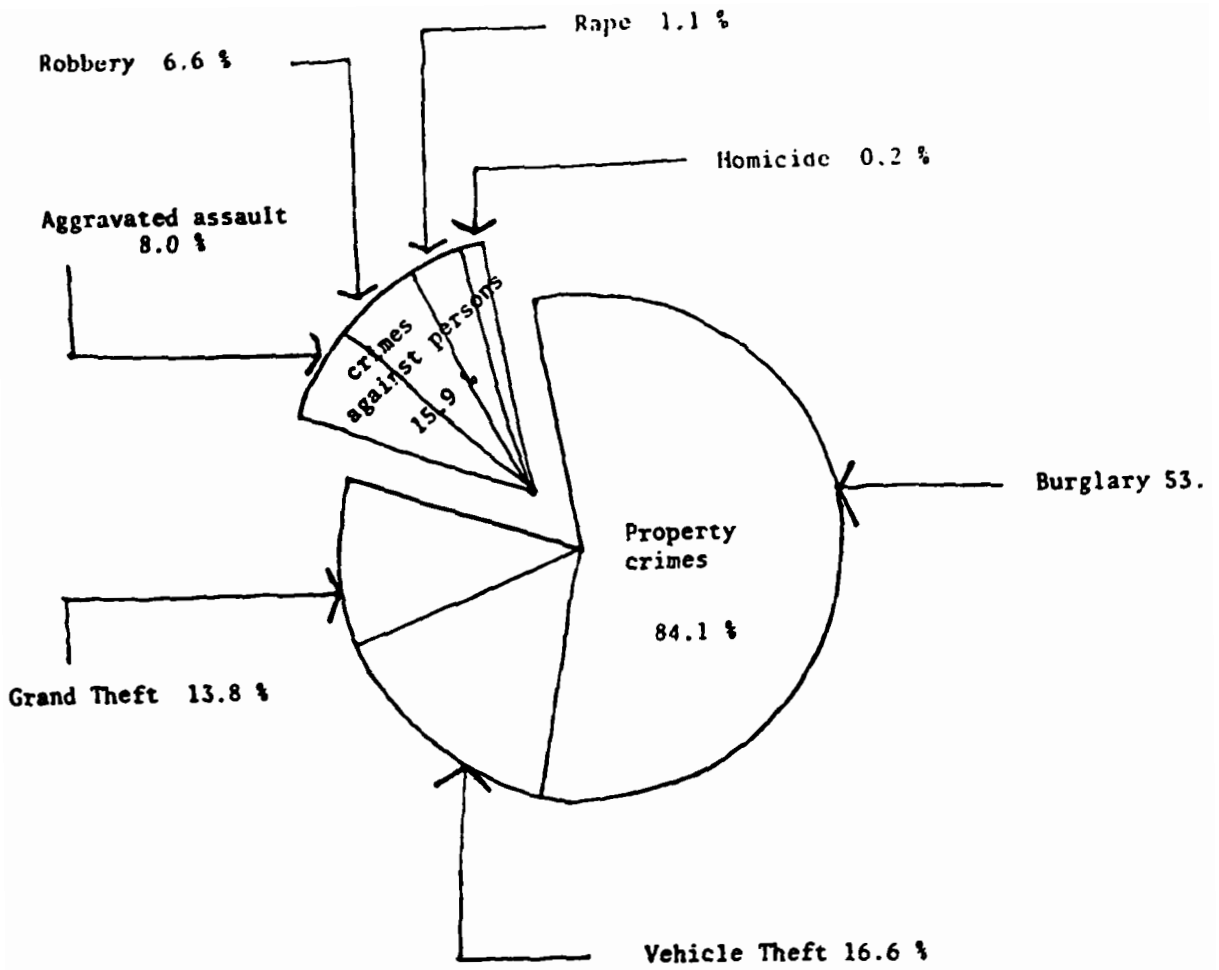

SOURCE: ( Taken from crime and delinquency in California in 1974, Dept. of Justice, Bureau of Criminal Statistics.)

Fig.

**TABLE Burglaries: Premises & Points of Entry**

Type of Burglary		Doors %	Windows %	Other %
Total burglaries	3,101	56	38	6
Residential	2,178	56	40	4
Commercial	800	58	39	3
Governmental or Institutional	123	46	43	11

Number of burglaries, six California Areas

April 1 to August 31, 1972.

SOURCE: California Attorney General's Building Security Commission, preliminary report to the California Legislature; Building Security Standards, Jan. 1973

**TABLE BURGLARIES: Premises & Tools Used**

Type of Burglary		Hands, Feet Used %	Tools Used %	Not Specified
Total burglaries	3,101	35	62	3
Residential	2,178	40	57	3
Commercial	800	23	74	3
Governmental or Institutional	123	26	71	3

Number of burglaries, six California Areas

April 1 to August 31, 1972.

SOURCE: California Attorney General's Building Security Commission, preliminary report to the California Legislature: January 1973

1960

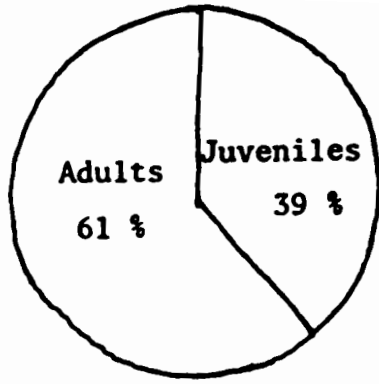

Total Arrest

1965

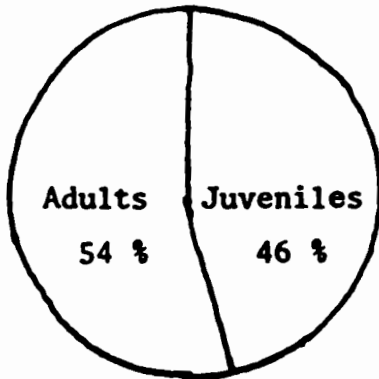

Total Arrest

1972

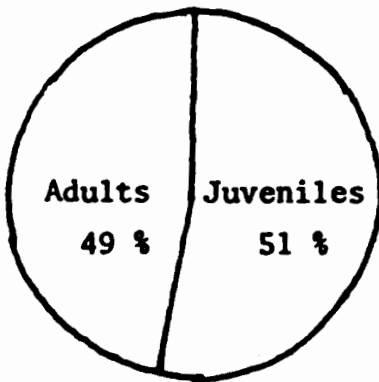

Total Arres

TABLE Distance from Burglary Scene to  
Offender's Residence

Distance	Total	Percent	Juveniles	Percent
Total Known	1,220	100.0	600	100.0
Within 1 mile	617	50.5	386	64.4
1 - 3 miles	257	21.1	124	20.7
3 - 5 miles	115	9.4	35	5.8
5 - 10 miles	112	9.2	26	4.3
Over 10 miles	119	9.8	29	4.8

SOURCE: California Dept. of Justice. Division of Law Enforcement;  
Research report No. 15, Bureau of Criminal Statisticts.

# **PROTECTION OF LOCALE**

## **SITE CONSIDERATIONS**

Site selection and the layout of facilities on a site can have significant influence on the cost which an organization may have to pay for security or a lack of it. Two financial benefits can be realized if effective security planning is done at an early stage. The first is a reduction in the cost of losses that threaten every organization, regardless of size or type. Some examples of such losses are fraud, theft, terrorism and sabotage. The second benefit that can be realized is a reduction in costs required to provide adequate security for the protection of assets and personnel.

The location of the site itself can have profound effect on protective measures that may be required. The three main factors that may have an effect on protection requirements are physical, social and political influences.

After a site has been selected and three factors just discussed have been carefully considered, the planning of the site to ensure protection at the least cost is the next objective in the design process. The use of the physical controls and the location of buildings and other facilities on the site such as parking lots, should be given emphasis.

### **PHYSICAL CONTROLS**

- BARRIERS, FENCES.
- SECURITY GATES & GUARD STATIONS.
- NUMBER OF ACCESS POINTS.
- DOOR AND WINDOW CONTROLS.

- LIGHTING.
- PARKING LOT LOCATION.

## **INDIVIDUAL SINGLE FAMILY HOUSES**

While When building or buying a house, aesthetics, structural soundness, cost of land and structure etc. are most urgently considered the question of adequate physical security is always overlooked. Based on commonly available statistics, burglary accounts for over one-half the major offenses. Little or no attention is given to whether the house is equipped with security hardware and if the doors, windows, locks are designed in a manner which will protect it from intruders. The physical security of a house needs to be considered from the time it is in a design stage on the drawing board.

Described in here are a few perspectives concerning the crime of burglary; to show what steps can be taken by the construction industry to counteract this crime.

Criminologists and police officials agree that if homes have installed adequate security hardware and occupants secure their doors and windows by these devices, an offender will not spend the time or make the crash needed to gain entry.



**Shoulder Impact**

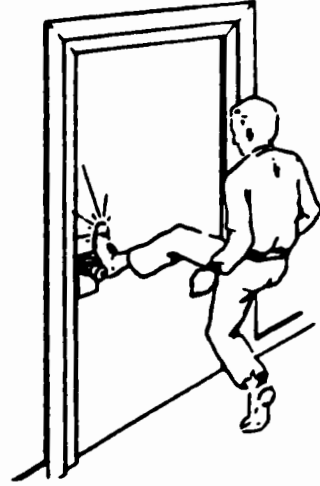

**Foot Impact**

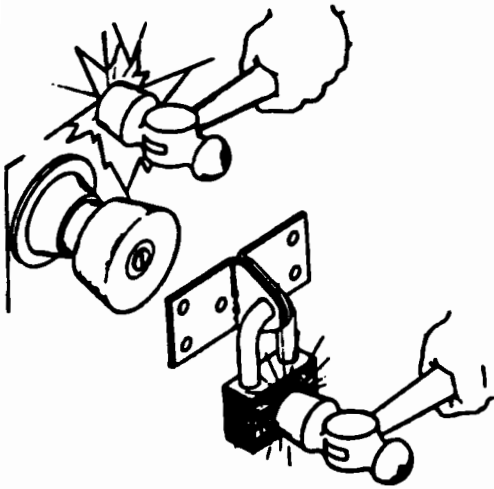

**Hammer**

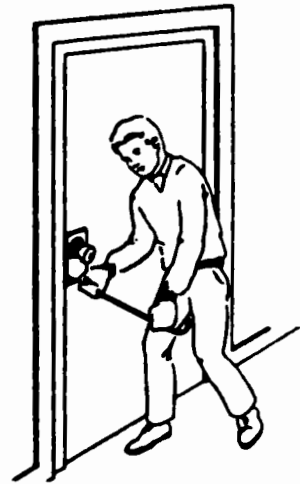

**Prying with bar**



GLASS BREAKING

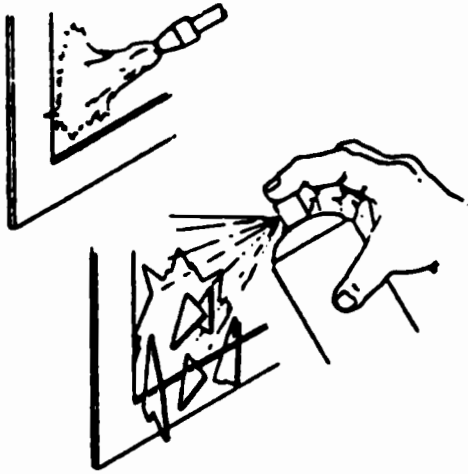

**Thermal Shock**



**Thrown Missile**

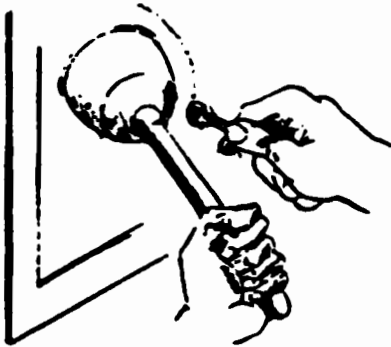

**Glass Cutter**

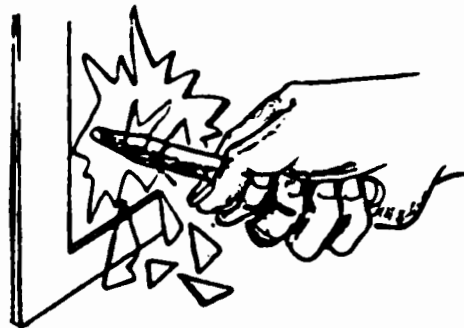

**Spring Loaded Punch**

LOCK BREAKING 3

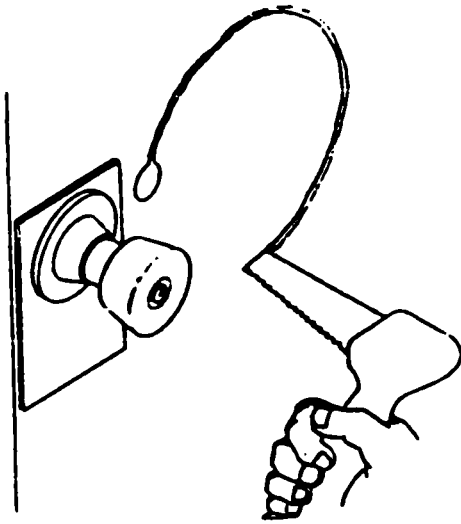

**Sawing**

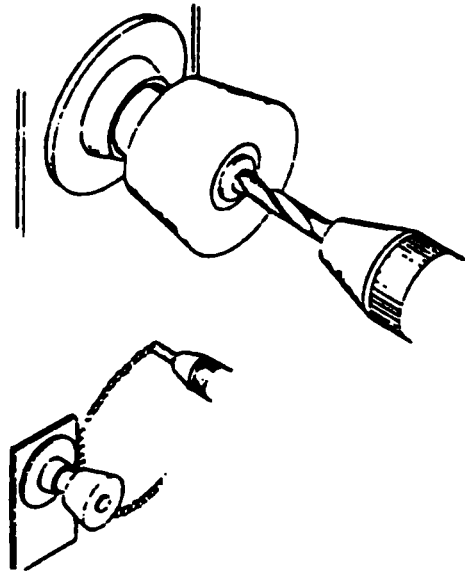

**Drilling**

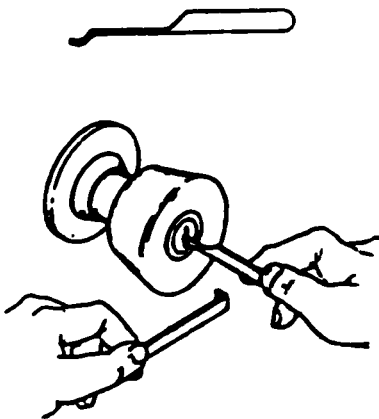

**Lock Picking**

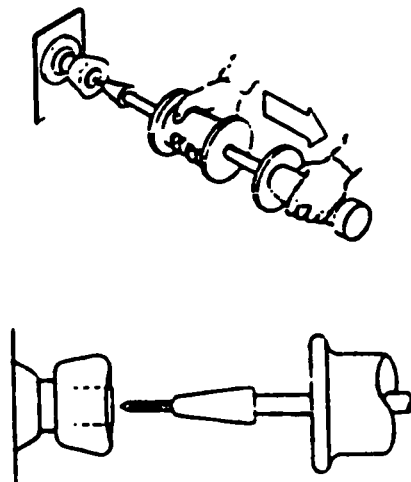

**Puller**

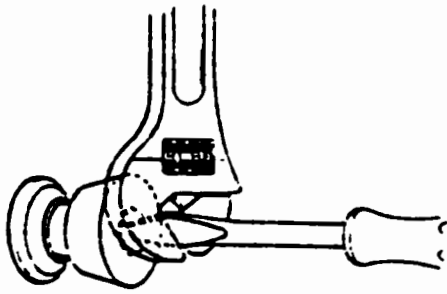

**Screwdriver and wrench**

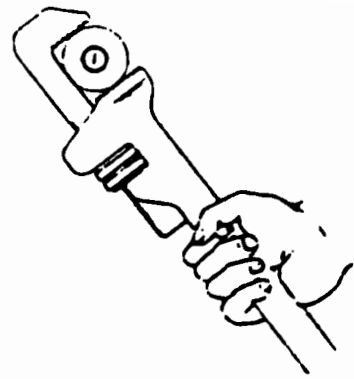

**Pipe wrench**

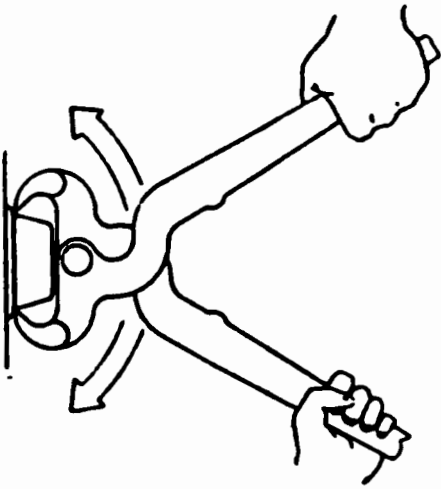

**Bolt nipper**

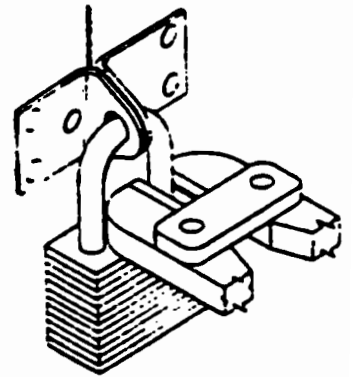

**Bolt cutter**

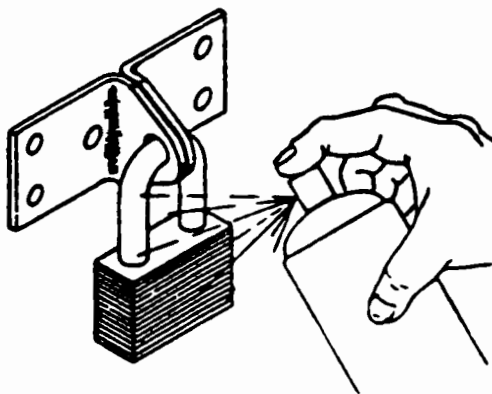

**Freezing**

## SECURITY HARDWARE

### DOORS

These are of two common designs: panel doors and flush doors. Panel doors consist of vertical and horizontal members framing rectangular areas in which panels of glass or wood are placed. Flush doors consist of flat panels running the full height and width of the door. See fig.

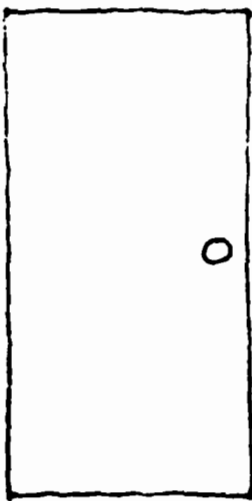

Flush Door

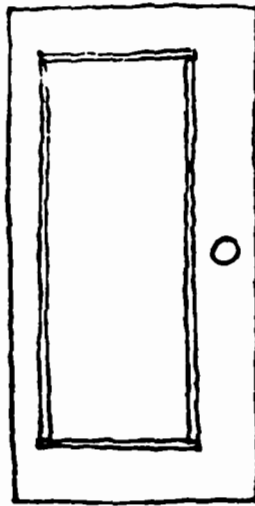

One-panel types

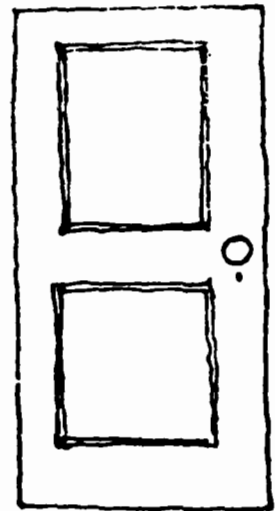

Two panels

All exterior wooden doors should be of solid-core construction with a minimum thickness of 45 mm (see fig.). Though flush doors provide better security, aesthetic may call for the use of panel doors; if so, glass panels should be at least 12mm thick. A glass panel area next to the door should be avoided in design; but if owner is adamant about having glass next to the doorway, special attention should be exercised. Firstly glass area should not be provided within 120cm of a door-locking device, and some kind of

steel grillwork be used to cover the glass. This will prohibit an intruder from breaking the glass, reaching in, and unlocking the door from the inside.

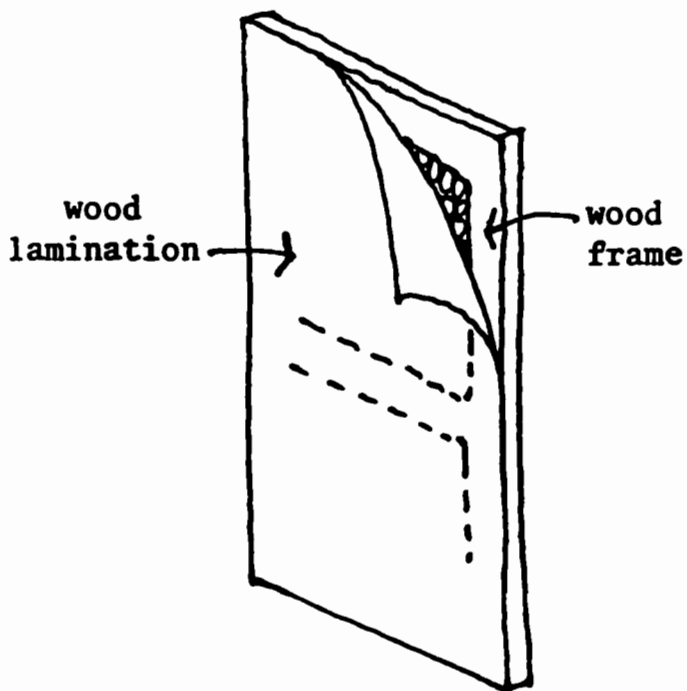

Hollow core

Fig.

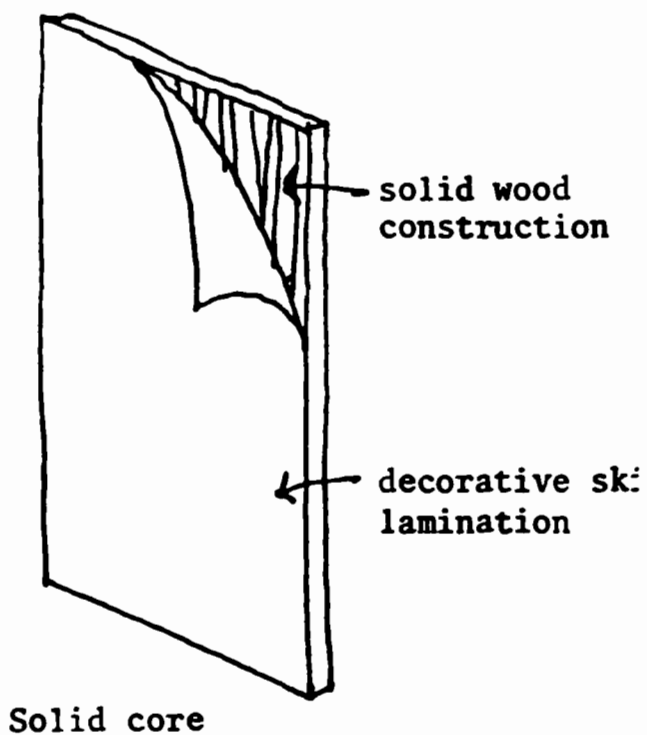

Solid core

## **HINGES**

Hinges on outswinging doors are especially vulnerable and the ease with which hinge pins can be pried upward and removed, thereby permitting the door to be opened from the hinge side.

Door hinges with a non-removable pin feature should be utilized, in addition extra pinning can be accomplished as shown.

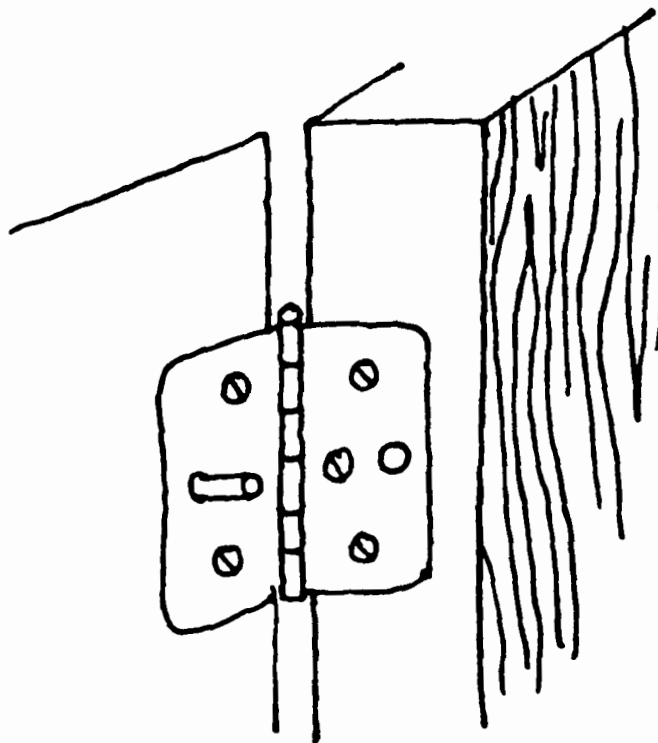

**Pinned Hinge**

**Hinge Protection.** To prevent lifting of door from hinges:

- 1 - Remove two screws, opposite each from both leaves of the hinge;**
- 2 - Insert screw or concrete nail into jamb, protruding  $\frac{1}{2}$  in;**
- 3 - Drill out opposing screw hole in door. Follow steps for top and bottom hinge of door. When the door is closed,**

the hinge pins can be pulled out, but the door will remain firmly in place.

## DOOR VIEWER

An additional security item in the total door system (see Fig.) is an optical viewer. These viewers range from 6mm to 76mm in diameter. These viewers permit one-way viewing and should be installed in the middle section of the door and at least 148cm from the floor.

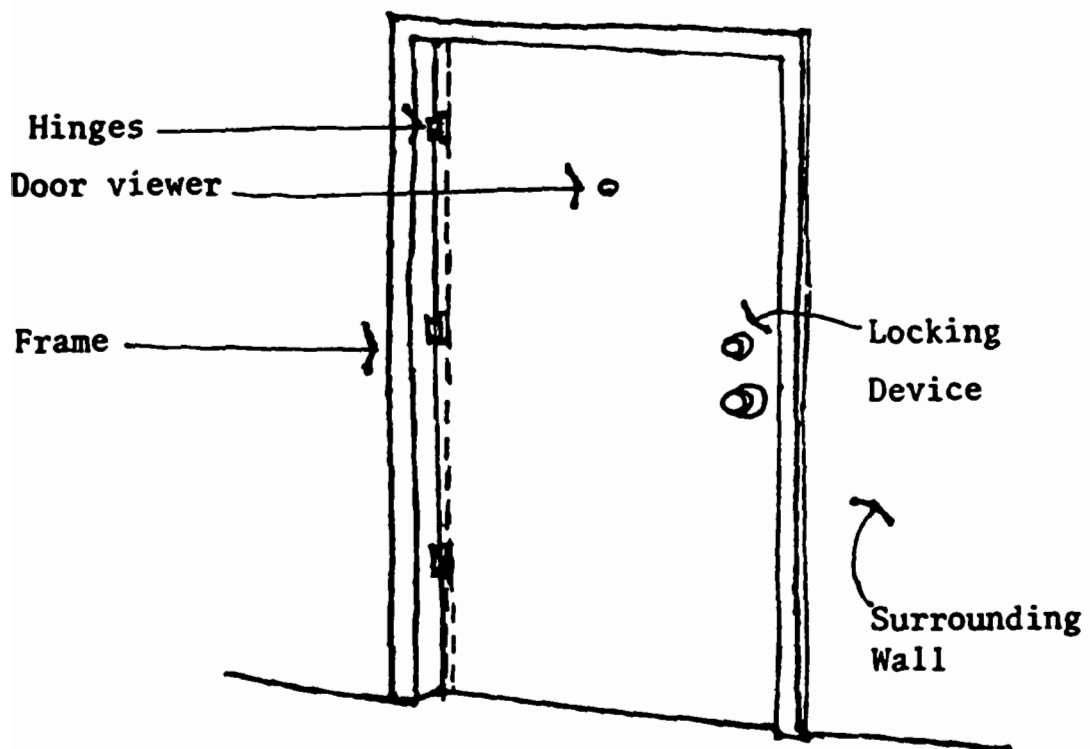

Door System. The strength of a system is as good as its weakest component.

## SLIDING GLASS DOORS

Sliding glass doors are a potential security hazard. They generally have inferior locking systems and can be lifted from the track and removed in no time from the frame.

Several preventive steps can be taken to upgrade their security such as:

- An auxiliary lock specially made for sliding doors. This ties the active and inactive leaf of the door together.
- Installing two pan-head sheet metal screws in the upper track of the active slider about 30cm. from each end and then adjusting them downwards until the sliding door just clears the track. This prevents lifting the door out of the frame.

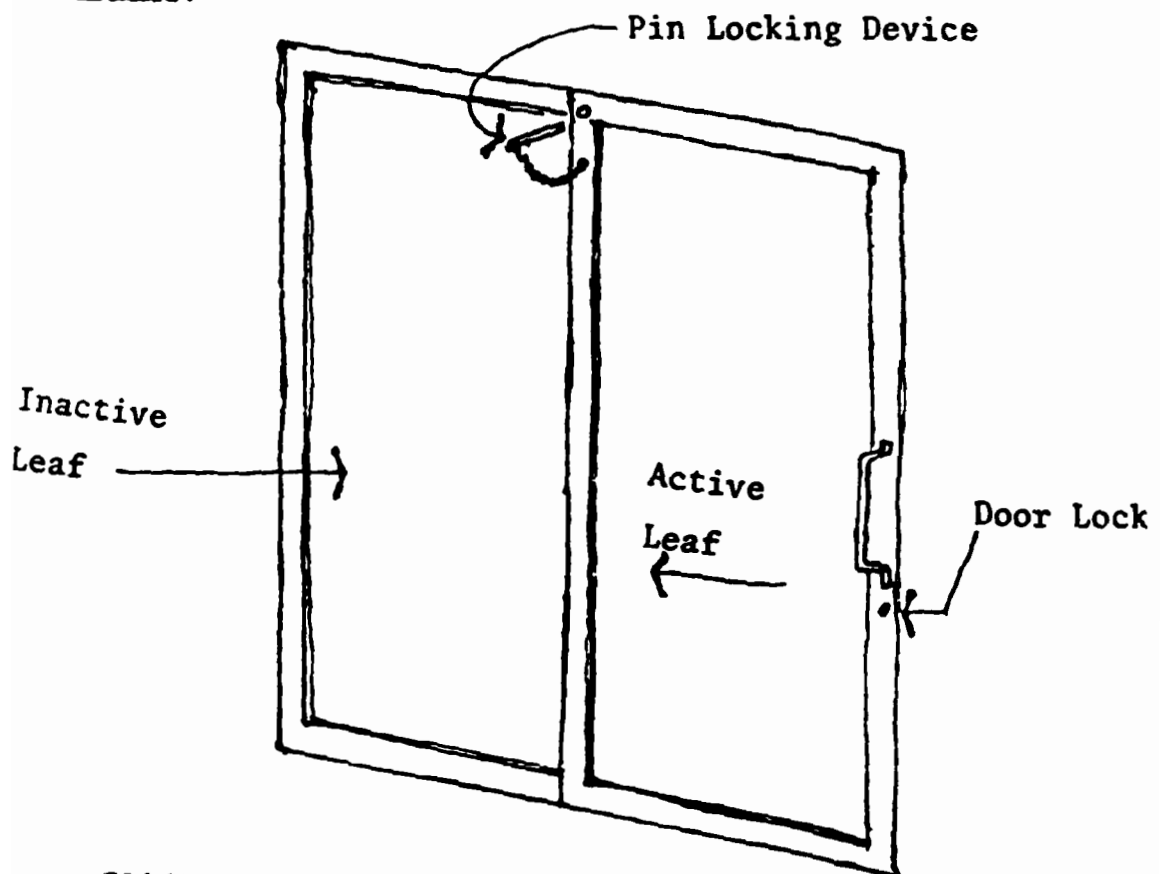

Sliding door with an additional metal pin on the inside to tie active and inactive leaf together.



## LOCKS

There are many types of locks for many purposes and locations. The best designed locks have hardened-steel cores and cylinder guards that can withstand physical attacks. Locks with bolts of 25mm length make it difficult for an intruder to gain entry by spreading the door frame and disengaging the bolt from the jamb.

For all exterior doors an auxiliary deadlock is recommended.

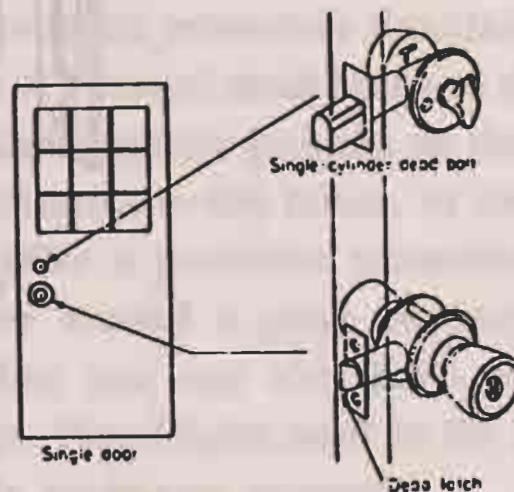

Auxiliary deadlock. Use 25mm dead bolt. Single cylinder with hardened cylinder guard and thumb turn.

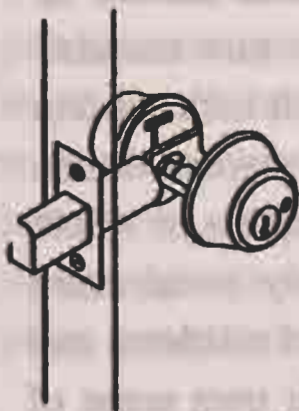

Auxiliary deadlock with 25mm deadbolt. If cylinder is locked when house is occupied, leave key in inside keyhole as a means of fast exit in case of fire.



Mortise lock

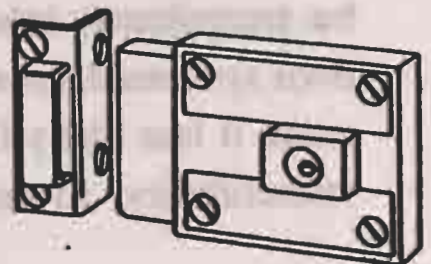

Rim lock

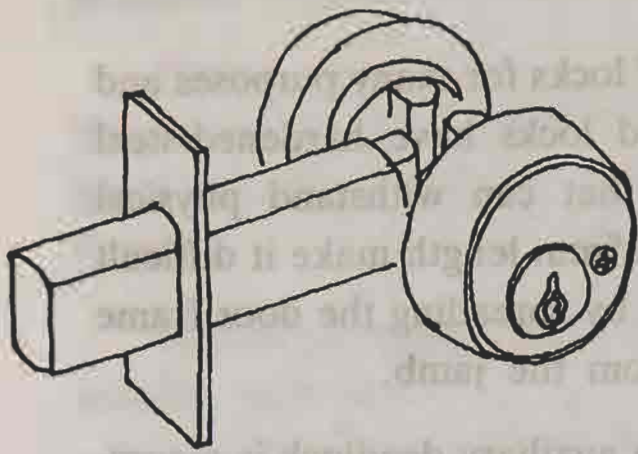

Schlage Series B  
Deadlock

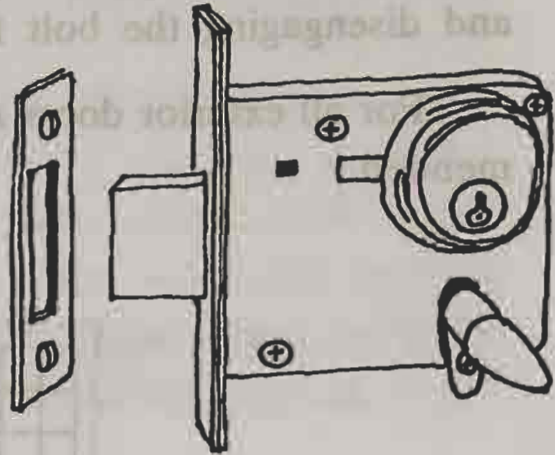

Yale 300 Series  
Mortise Lock

## POSITIVE LOCKS

An optimum-performance lock apparatus should always be employed. Many building codes are now mandating more stringent laws and require dead bolt locks and/or prohibit poorly constructed jambs and hollow-core doors. In addition to providing easier access for burglars or would be trespassers, inadequate locks and poorly constructed door systems decrease the sense of security of residents and make it less likely for them, because of their own sense of vulnerability, to respond in ways which inhibit crime.

## **FORMS OF PROTECTION (ALARM SYSTEM)**

Depending on its design and installation, an intrusion alarm system may provide for any of several different forms of protection. It may serve, for example, to detect an intruder trying to enter a protected area, or the system may respond to an unauthorized person anywhere within the premises or in a specific room. Finally, the system can be designed to respond only if the intruder approaches or touches a specific object, such as a single door, a safe, or a file cabinet. Sometimes a single installation can be set up to furnish two or more forms of protection simultaneously. Consider the floor plan of a typical small house as shown in the illustration. If an alarm system protects all the doors, windows, and other entrances to the house, or the entire exterior, it is said to offer a perimeter protection. In a physical sense, a fence around a piece of property is perimeter protection. But you can also have perimeter protection in other ways. Flood lights used on the grounds around a house supply perimeter protection.

If an alarm system can detect an intruder anywhere in a given area, such as the living room in your home, it provides area protection. If finances permit, you can set up several such systems to protect those rooms containing your valuables. A safe or a strong closet containing jewellery, documents and valuables can only be set up with a detection system and this would be classified as a point protection.

FORMS OF PROTECTION (SYSTEM)

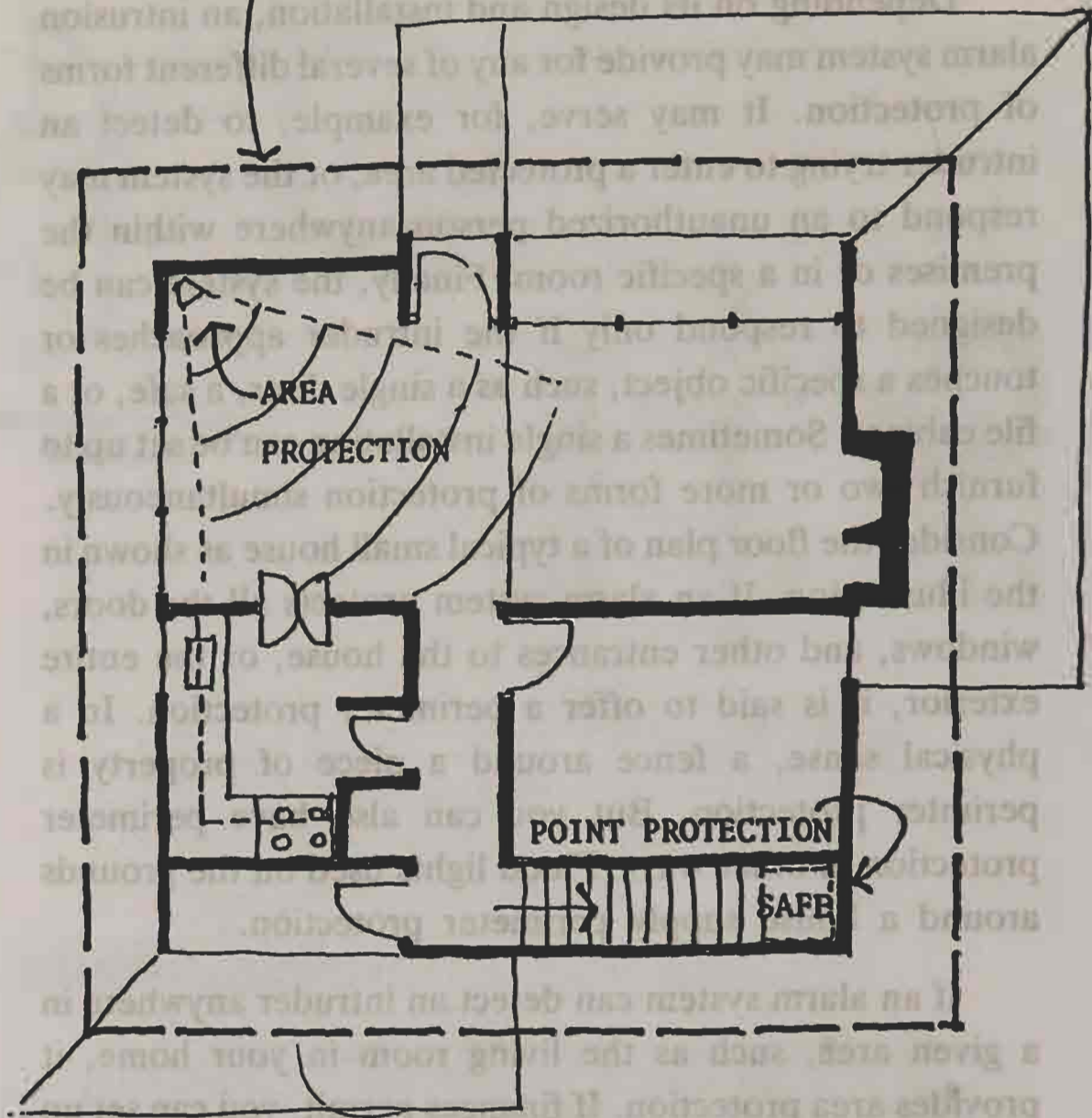

**There are three forms of protection: Perimeter, Area and Point. This plan shows all three types (hydrometal Inc.).**



## **MULTI-FAMILY HOUSING**

To create a historical background for the factors contributing to increase of crime, it will be useful to study the general design characteristics of housing projects suffering high crime occurrences. There are five or six physical characteristics that reinforce criminal behavior, and these occur both in developments built for low and middle-income groups. The projects are usually large, accommodating over a thousand families, and consist of high-rise towers more than seven storeys in height. The sites are like a super block equal to four to six city blocks, and closed to city traffic. The buildings on the site are arranged in a free compositional manner. The grounds are conceived as a continuous space, moving freely among the buildings. Site design seldom shows any attempt at differentiating the grounds so as to make its portions relate to a particular building or group of buildings.

Buildings are generally designed with a single lobby facing onto the interior grounds of the development. The lobby, itself contains a mail box center and a waiting area for a bank of two to four elevators and giving access to various residential units on each floor from a central corridor.

To furnish required exits for times of emergencies, two or more emergency stairs are provided, running the full height of the building. These exits are in addition to the main entry.

What has just been described will no doubt be seen as a common phenomenon, well within the experience of most urbanites. The only difference between a low-income

and high-income development is the presence of fences and guards in the upper income projects, or a doorman provided for each of its buildings. The slight additions and differences, however, are what make the one a workable habitat and the other not. The same urban high rise residential developments for low and middle-income families, devoid of the doormen, guards, and resident superintendents, become domains for criminals.

A usual concept of the planner is based on the notion of automobile-free super-block. Whenever a site consisting of four to six blocks of existing urban fabric is assembled, it is taken for granted that in the new plan the intervening streets will be closed off. It is an erroneous thinking that closing of streets produces more grounds used in the calculation of density and so producing more housing units on a particular site.

The streets provide security in the form of prominent paths for pedestrian and vehicular movement; windows and doorways, when facing streets, extend the zone of residents' territory and also allows for continued casual surveillance by police in passing cars. Jane Jacobs in her book "Death and Life of Great American cities" contends that the surveillance provided by the casual passerby on foot or in a car is important as a deterrent to criminal activity.

In all the modern societies, statistics have revealed that crime rate has been found to increase almost proportionately with building height. In New York City, 95 percent of the Housing Authority's projects greater than six storeys in height and larger than a thousand units in size

have higher crime rates per thousand population than those which are both smaller and lower.

The specific area within a high-rise building that is most vulnerable - the elevator - is a prime example of an area lacking surveillance. Thirty-one percent of all robberies in all housing projects occur within elevators. The victim may then be moved at the threat of force to the apartment, or in the case of rape, to the sealed-off fire exits or roof landings, where traffic and observation are rare (See Table).

SPACE	EXACT LOCATION	ALL PROJECTS *			
		BURGLARY	RAPE	ROBBERY	ASSAULT
Interior space	Apartment	2,087	16	62	54
Public Space (Interior)	Lobby	7	-	521	18
	Elevator	1	13	1,490	10
	Stair way	-	14	286	14
	Roof/Landing	3	39	7	3
Non-tenant space	Social facility	213	-	3	2
Exterior Public Space	Grounds	3	8	1,419	107

\* All incidents reported to NYCHA Police in 1969

Evidence indicates that those spaces which people must use on a continuing basis to get from the public area outside the project to the safety of the interior of the apartment are particularly dangerous if screened from natural observation and from formal patrol. In this light, the elevator is a space public in nature but totally screened from all observation.

## **FOUR THEORIES OF CRIME PREVENTION THROUGH ENVIRONMENTAL DESIGN**

### **1 - Social Control Theory:**

The “social control” is suggested by Jane Jacob’s well-known portrayal of New York’s Greenwich Village. She pointed out that a city street is populated with strangers. Streets remain under a form of functional surveillance which results from the diversity of uses one finds in truly urban settings.

Business establishments and stores give people a reason for using streets and sidewalks, that is, they create a flow of pedestrians. This view of the role of commercial facilities has reversed the notion that these intensely public areas attracted crime.

### **2 - Enclau - Access Control Theory**

It suggests that the environment can be designed to discourage the access of prospective criminals to potential victims.

Lobby attendants in large apartment complexes and



guards monitoring walled-in communities serve the role of gatekeepers.

Residential applications of this system are numerous, varying from door buzzers and intercom systems to complex alarm and intrusion-detected systems.

### **3 - Criminal Justice Theory:**

This approach focuses on the presence of police as a primary deterrent to crime. It suggests a form of environmental design in which standards of lighting and access are maintained so as to provide optimal conditions for police patrols. In essence the approach focuses on crime prevention through making prospective criminals aware of the presence of public authority.

All entrances to residential buildings are clearly marked and lighted.

Streets are simplified and street angles symmetrized in order to provide clear, unambiguous access. Stair halls and elevator areas should be well lit and exposed to view from the street, especially from passing cars.

### **4 - Defensible - Space Theory**

It suggests that crime is less likely when potential anti-social acts are framed in a physical space that is under observation by others. The effect of simple observation as a mechanism of social control is greatly increased when observers know one another, or when they are associated together by means of some common territorial marker.

Large number of crimes among the unacquainted are

**spontaneous crimes in response to opportunities that present themselves in anonymous settings.**

**The basic elements of environmental design that relate to security are:**

- Surveillance opportunities.**
- Space differentiation.**
- Recognition of territory.**
- Separation of conflicting uses.**

## **THE SEARCH FOR DEFENSIBLE ENVIRONMENT**

**The eye of the criminal searches for inconsistency and ambiguity. As surely and stealthily as an animal searches for its prey, the would-be criminal scans the environment for any sign of defect or vulnerability. It is a constant search. Every element of the environment, each door, each lock, each walkway is tested visually or manually, at some time or other. In multi-occupancy housing development, these informal inspections take place all the time. Where a poor lock on the door, a removable hinge, or a window near a front-door lock for easy break-in is a serious error in a single home, in an apartment complex, it can be the cause of twenty or more burglaries.**

**Simply assuming that the environment is being tested for its vulnerability all the time can produce a radical change in perspective. In the past many housing developments were designed from a two-fold perspective. First the building was viewed as a marketing image and as an advertisement for itself - what life-style or income group did it suggest? Second, the building or project was essayed**

in terms of the attractive features it offered the consumer once inside the apartment.

Now we must add to these considerations:

- 1 - The sense of vulnerability which the building and its residents display to prospective criminals.
- 2 - The role of the project in enhancing security in the surrounding area.
- 3 - The access which the building provides to other concerned neighbors, to police and other authorities.

Environmental design is an advance statement of social intentions. The structure and appearance of the setting frames, the will of a community or user group. The visual nature of the physical setting is taken by strangers, passersby, and would-be criminals as a sign of willingness of residents as a group to respond to “troubles”, to monitor and control strange or unusual happenings in and around their buildings. Crime deterrence results from environmental communication -everything from window locks to high fences and controlled perimeters. Environment design offers a symbolic language of using architecture and planning the type of setting in which they live, to suggest preventive measures in securing defense against crime. Following pages illustrate some categories of preventive measures.

## DISTINCTIVE ENTRANCES

Allow a series of entrances to sub-portions of a complex which are distinctive. A building may include many living units, where possible, a series of entrances should be visually available and identifiable with entrance configuration and archways through which passage is achieved. This design diversity will in turn create an atmosphere of territory, thereby discouraging vandalism and littering or loitering.

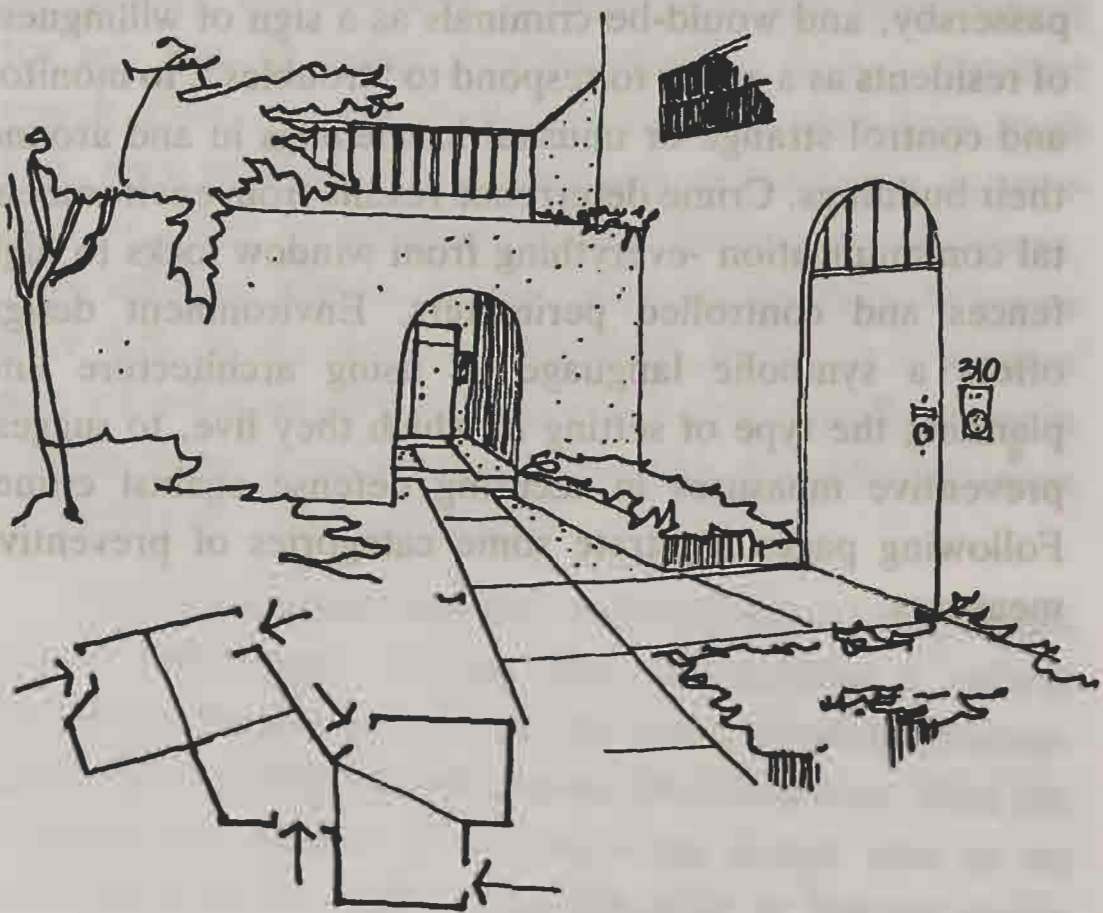

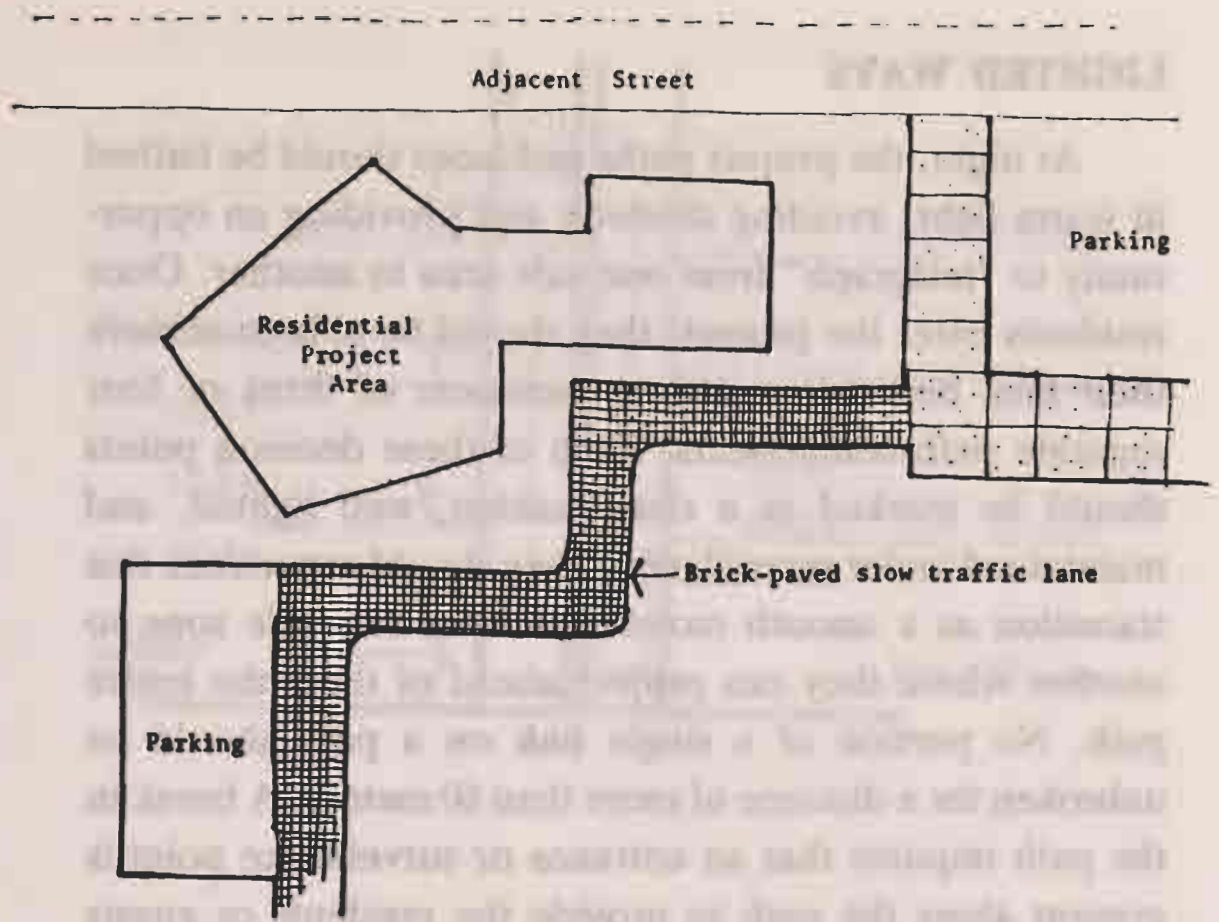

## **SLOW TRAFFIC**

Numerous studies have been made on the effect of movement of traffic on the sense of community and on the interpretation of responsibility for maintaining surveillance on conduct in adjacent street areas. Optimum arrangement is to have some auto traffic brought into the body of the project or passing through it. This provides residents with the sense that there is direct access for both passersby and cars and police. The traffic pattern must be sufficiently regulated, so that rapidly moving cars cannot negotiate the route easily. This can be done by a combination of curbs, barriers or a simple change in materials to a brick surface.



## LIGHTED WAYS

At night, the project paths and lanes should be bathed in warm light, avoiding shadows and providing an opportunity to “telegraph” from one safe area to another. Once residents enter the project, they should be able to achieve their final destination with a maximum of three or four separate path components. Each of these decision points should be marked in a clear fashion, well lighted, and maintained under surveillance. They should experience this transition as a smooth movement from one safe zone to another where they can project ahead of them the entire path. No portion of a single link on a path should be unbroken for a distance of more than 60 meters. A break in the path requires that an entrance or surveillance point is present along the path to provide the residents or guests with a sense of safe access.

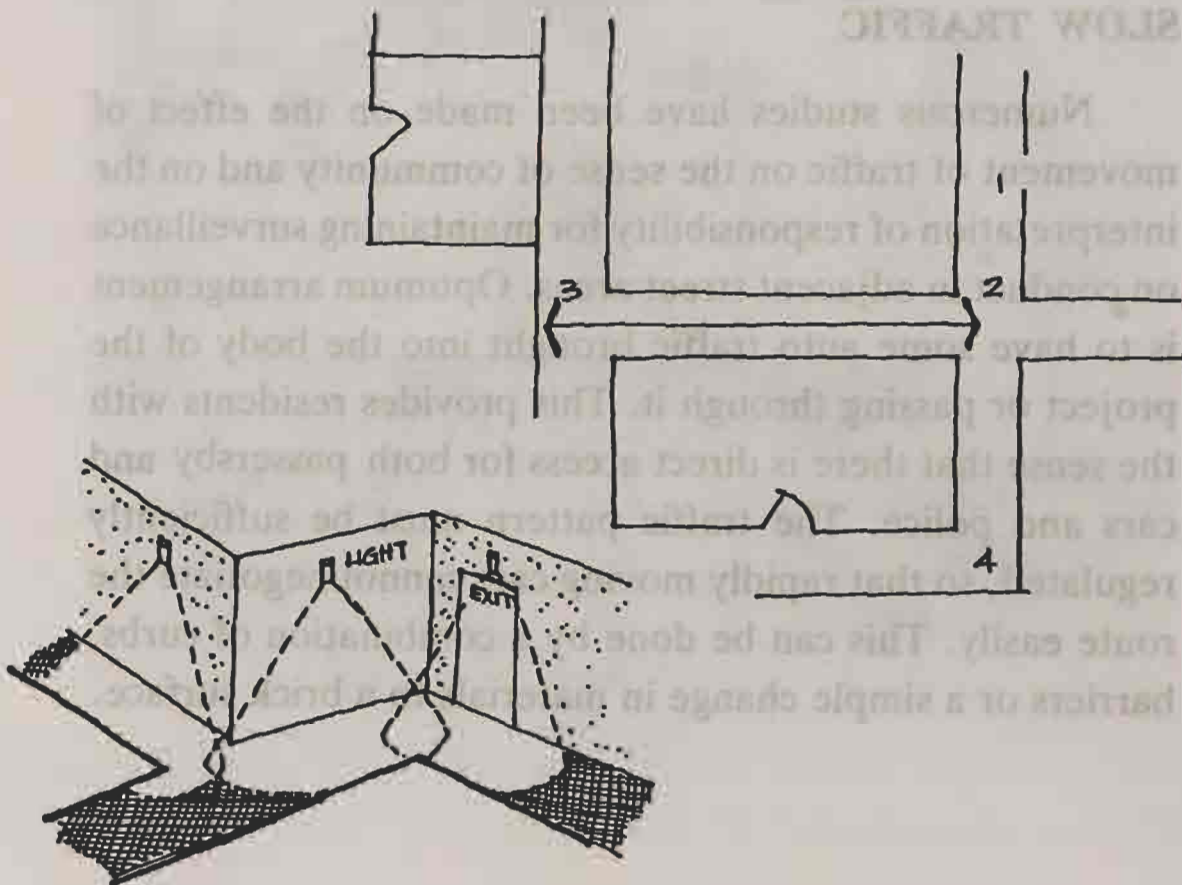

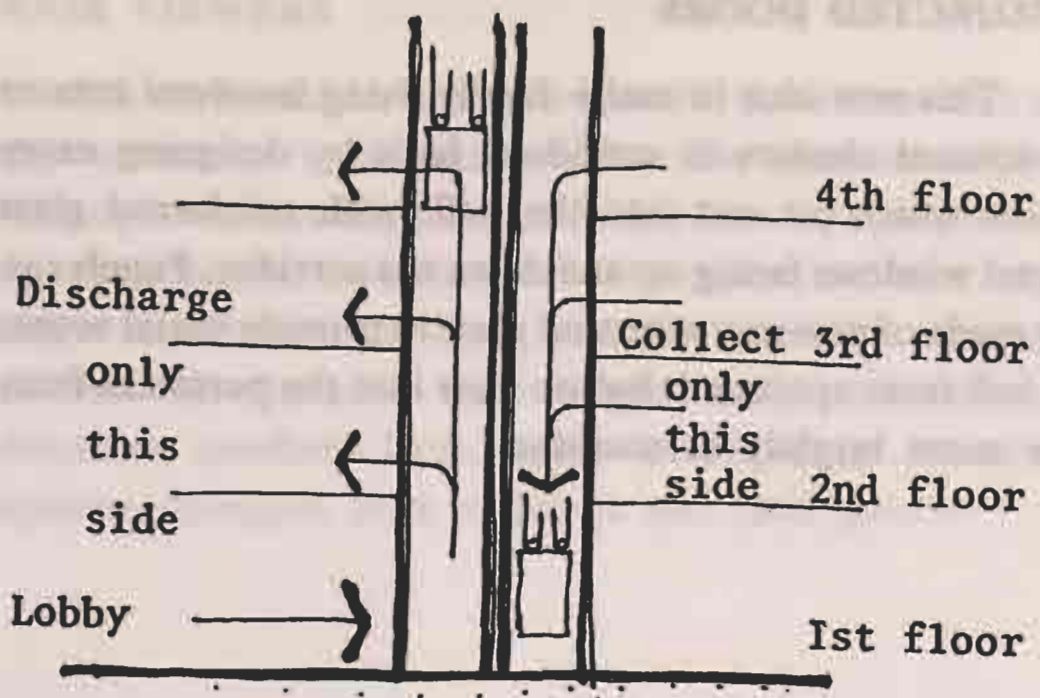

### **ELEVATOR SAFETY SYSTEM (DISCHARGE-COLLECT)**

Systems have been designed to prevent elevator crimes. The program allows discharge only on the way up, making it impossible for an assailant to press a call button at an intermediate floor to surprise a rider. One must return to the 1st floor (ground floor) to go "up".

## PROJECTED DOORS

This new idea in multi-family living involves/ creates apartment clusters in corridors/ halls by designing entry doors which jut out into the hall, with reinforced glass panel windows facing up and down the corridor. Panels can be made of one-way mirrored glass to provide visual access to hall from apartment but no view into the partment from the more brightly lit corridor.



Solid one-way viewing glass  
at entry door



## DOOR VIEWERS

Efforts should be made to provide visual access to as large an area as is plausible close to the apartment door. Periscopic viewers might be developed for this purpose to allow residents to look to one or the other end of a hall. These mechanisms serve as interior windows, allowing residents on the same floor to get needed information about one another's lives, family members etc., so as to separate strangers from residents and their guests.

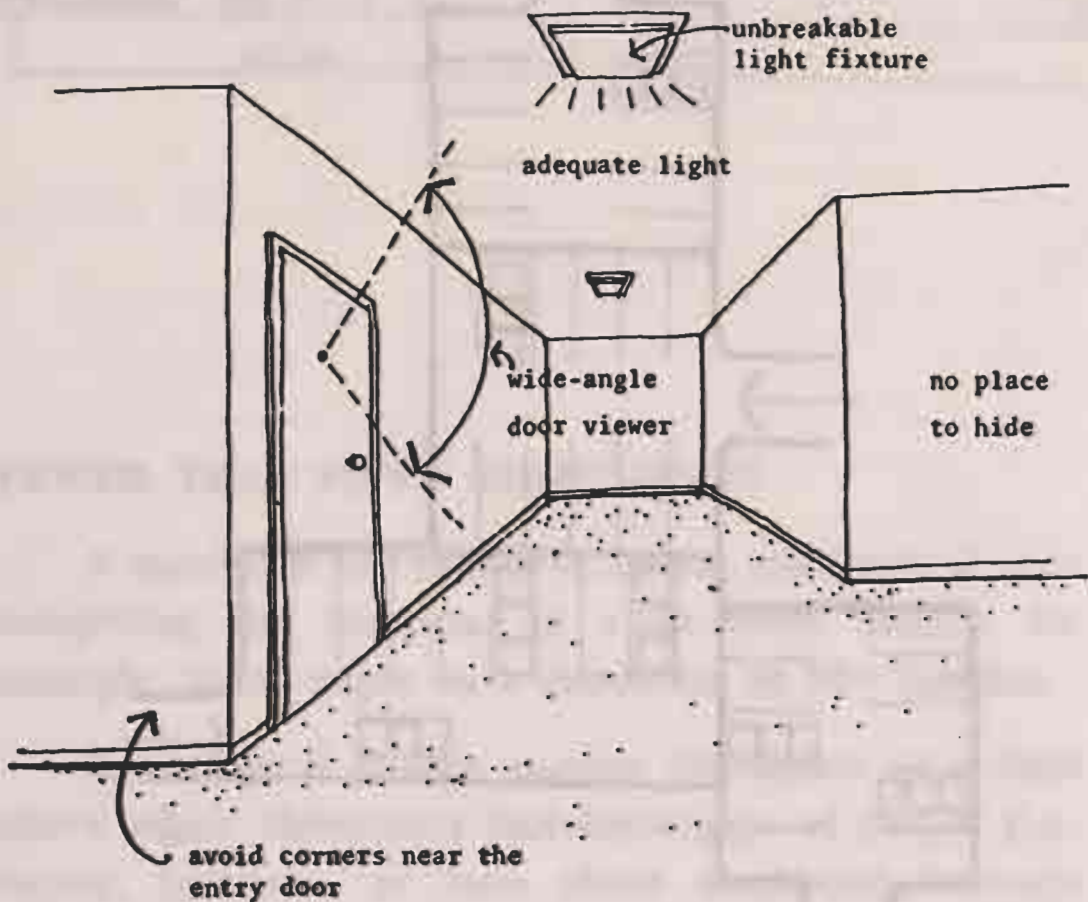

## SUB-DIVIDED PARKING GARAGE

In multi-family developments, where possible, avoid the phenomenon of long underground passages with many pedestrian entrances and exits. Large underground garages should be broken into smaller sections served by separate entrances. This effectively eliminates the risk of strangers moving freely among vehicles or preying upon residents far from exits or access to help.

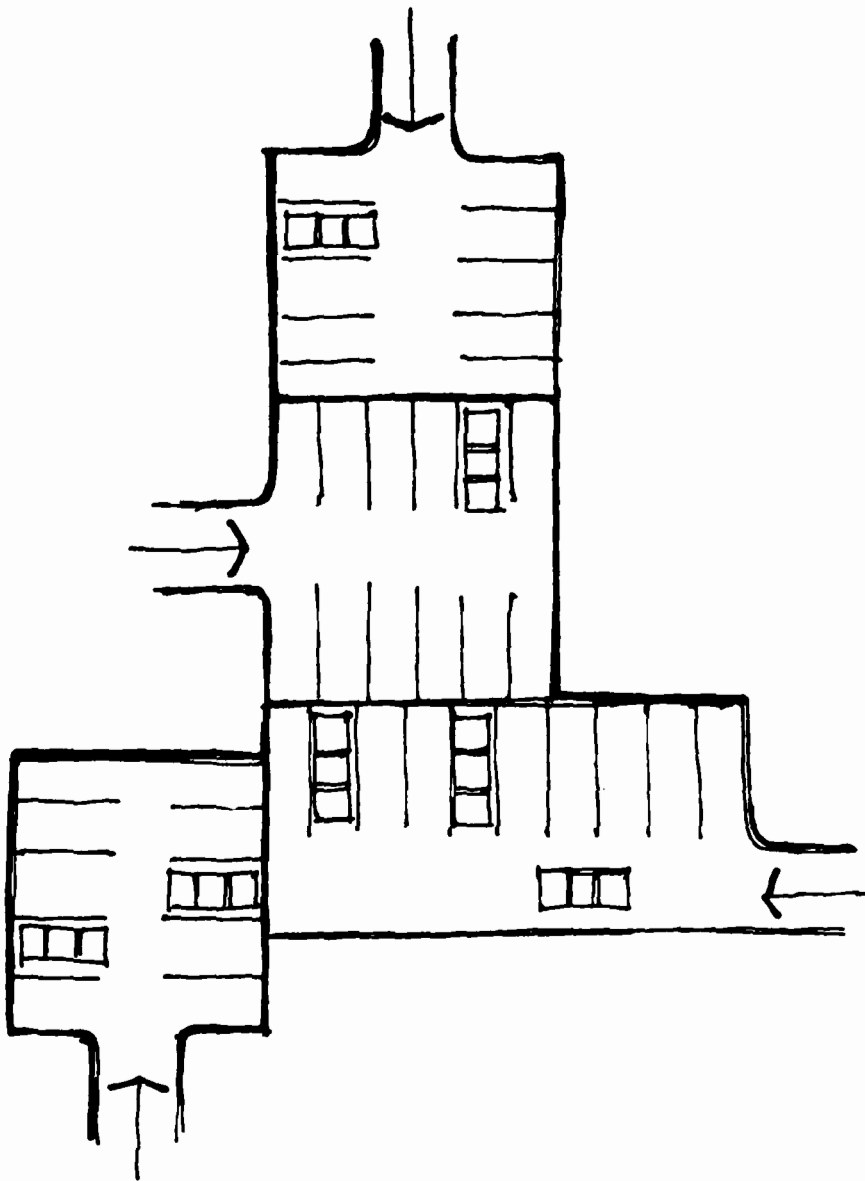

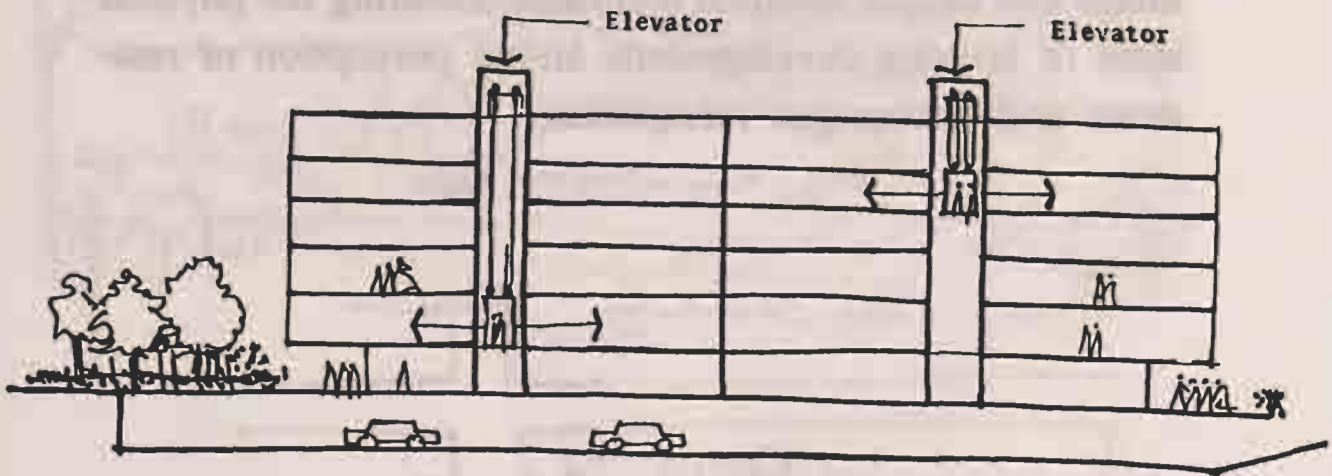

## FEWER THAN FIFTY APARTMENTS

A maximum size should be set for architectural units comprising the complex. In a six-storey facility, for example, there might be a maximum of fifty families.

Psychological studies suggest this figure as a limit above which elementary face-knowledge of people (i.e., names, locations, or facts about neighbors) becomes difficult to comprehend in a community of strangers. If at all there has to be a greater number of families, than above, in a building then a distinctive social bond must be added.

## LIMITED SIZE FOR A PROJECT

In any prospective project, no more than 500 families should be grouped/ housed under a single name. Plan should be modified for each 500 family unit to provide these large groupings with a distinctive physical design and image and unique nominal identifier. Limiting the physical scale of housing developments allows perception of residents and encourages recognition.

500 families  
maximum  
per project

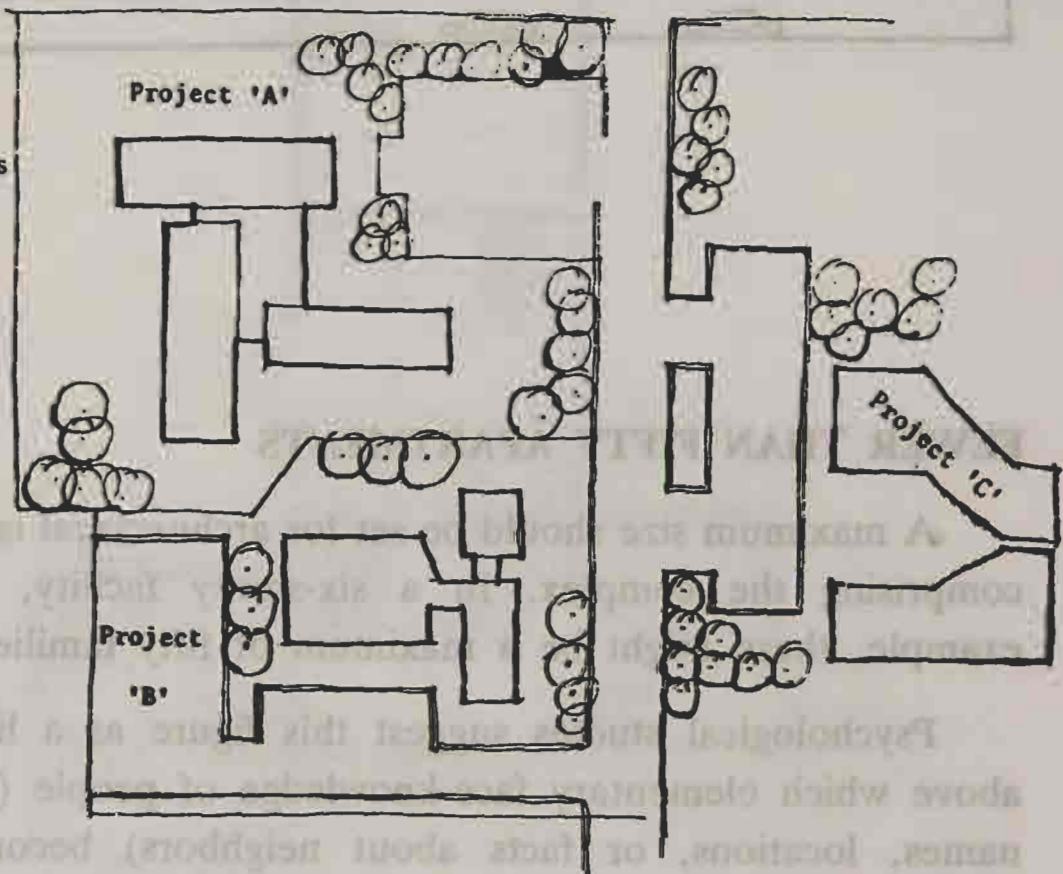



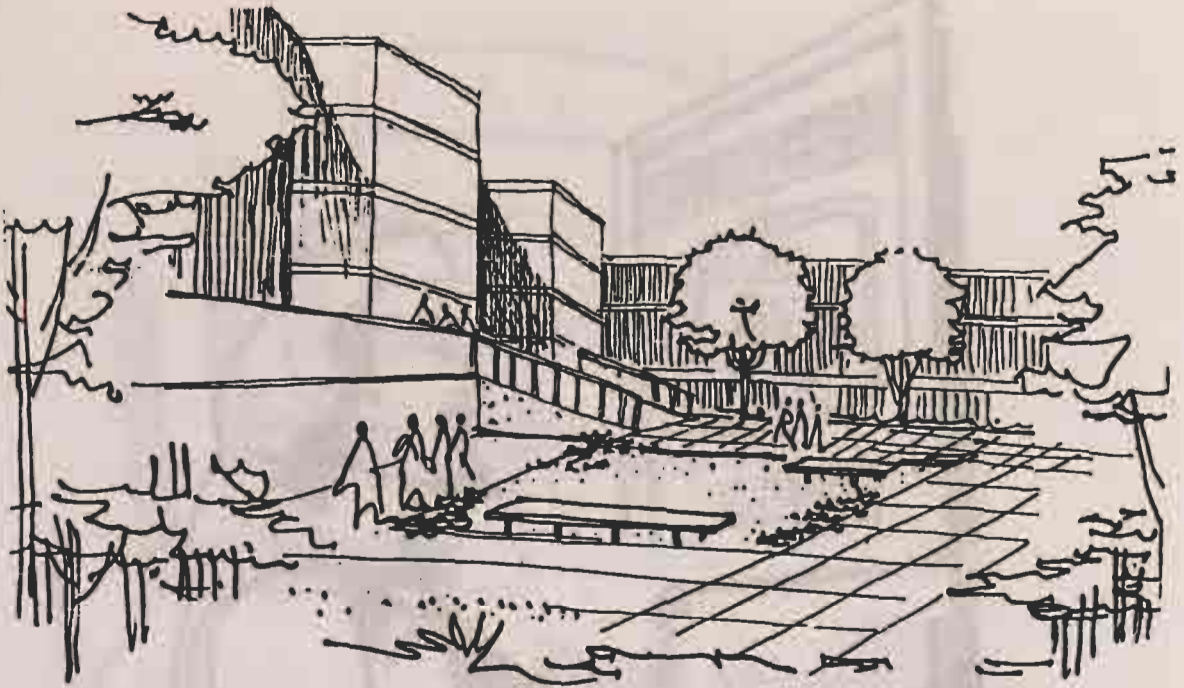

## **SHARED INTERIOR COURTS**

Where possible, semi-public areas should be divided into courts, plazas and gardens which are shared by three to eight groupings of units. These spaces may vary in size depending on the scale of a project and the quality of the design density within the project and in the surrounding community.

Some visual expression should be given on the ground level for each distinctive architectural unit. For example, if a building complex includes four groupings of twenty-five families, there should be some clear indication of a common zone, space, green area or facility which reflects the shared use of these groupings.

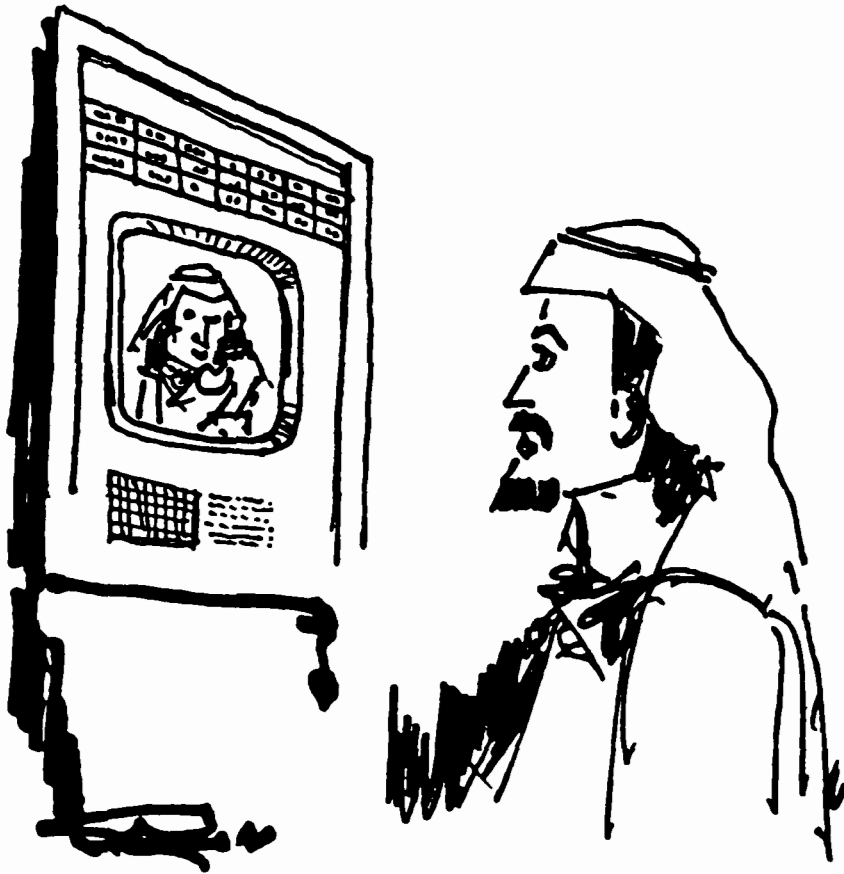

## **COMMUNICATIONS WITH GUESTS**

Video and audio monitoring systems for guests can be very productive in multi-occupancy communities. Operated at very low cost and on residents' own television sets, these interviewing systems can be introduced in a way that allows people to think of them as positive aids to communication, making possible more and safer interactions with guests and strangers and allowing for more spontaneous interchanges among neighbors.

In practice, it allows people to call into the body of the project - upon arrival - and be seen by their prospective host residents, and be invited upstairs. Mothers can communicate easily with their children asking them, for example, to return from play areas.

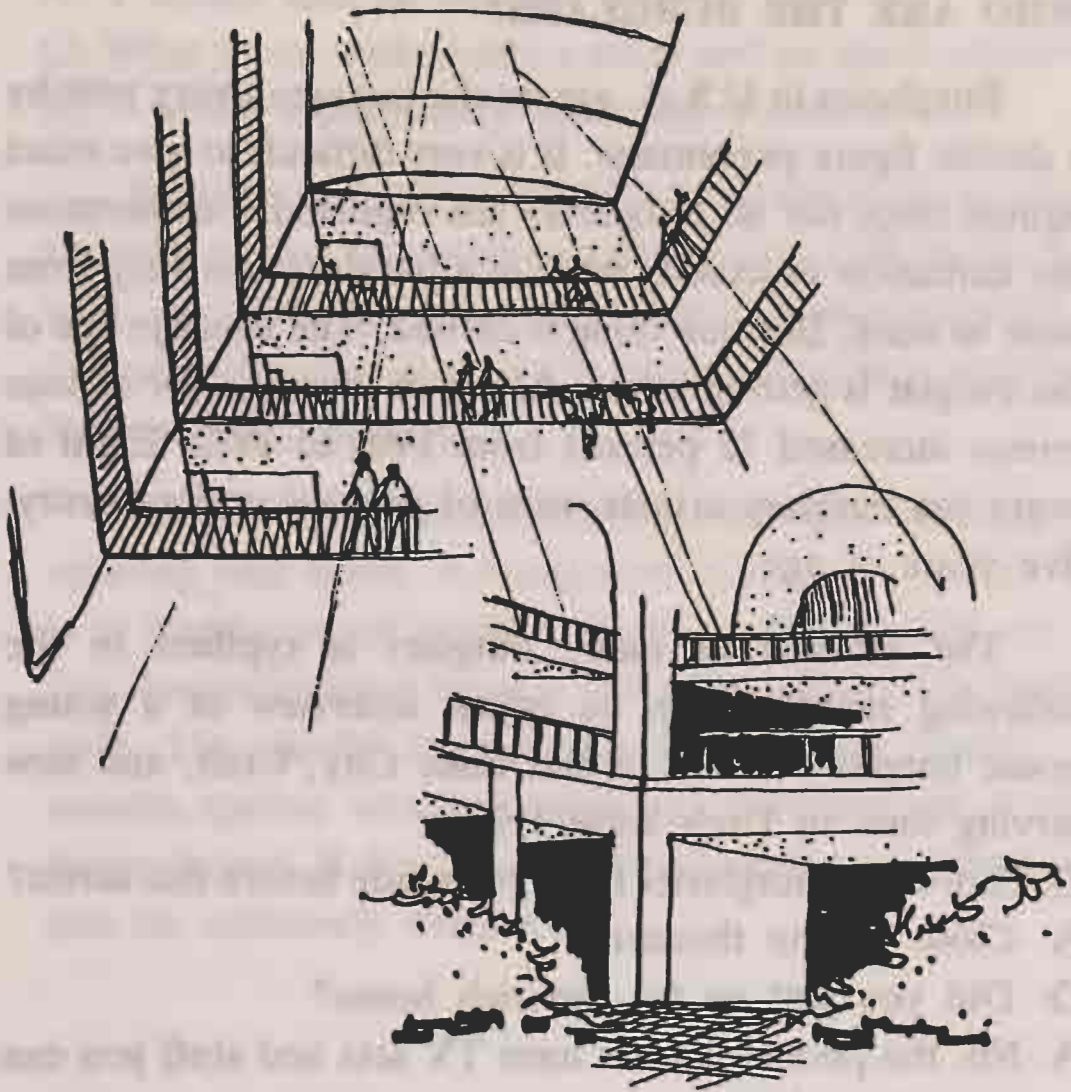

## **VERTICAL STREETS**

If high buildings are employed, opportunities should be created for protected circulation within each building other than at the street level. The center of the building can be provided with a large multi-storied open space.

Apartments are linked by exposed internal corridors with balconies circling the atrium. This provides a very safe atmosphere because residents coming from and going to their apartments can be seen across the open space. Other configurations which produce the same effect are also possible.

## **WHO ARE THE BURGLARS?**

Burglaries in U.S.A. are on the increase every year by a double figure percentage. It is very difficult to give exact figures since not all burglaries are reported. Furthermore the definition of exactly what is a burglary can vary from state to state. But one thing is certain. The average age of the burglar is getting lower. Arrest of juveniles for serious crimes increased 72 percent from 1900 to 1972. Eight of every ten burglary arrests were of persons under twenty-five years of age.

The attitude of many burglars is typified in the following excerpt from an actual interview of a young house burglar arrested in Salt Lake City, Utah, and now serving time in Utah State Prison:

**Q: How many burglaries have you made before this arrest?**

**A: Close to one thousand.**

**Q: Did you just go for the rich home?**

**A: No, the poorest homes have TV sets and stuff you can move in a hurry.**

**Q: What about dogs?**

**A: They did not really give me a problem. Dogs outside can be fed or put out. If a dog is in a house, he usually thinks you belong there.**

**Q: you would go into a house with a dog inside.**

**A: Yes.**

**Q: Why do you think people are complacent about protection?**

**A: Most think they don't have anything worth stealing.**

**Q: Have you ever been in a house where you could not find anything worth stealing?**



**A: I would kick in the TV set.**

**Q: What if you walked into a room and an alarm sounded?**

**A: I would immediately leave the premises.**

**Burglars in America are now breaking-in the houses at the rate of five thousand per day. Using 1960 as the base year, by 1970 night-time burglaries of residences were up 129 percent. On that same period day-time burglaries increased 337 percent.**

**Burglary isn't the only driving motive for breaking and entering your home. A burglar-proof lock - i.e., a lock that is as burglar-proof as you can get - will help hold out not just the professional burglar, but other undesirable types as well. The vandal breaks into a home for "kicks". He resents anyone who has anything, including just a good, happy house. If discovered while breaking up a house, he can be extremely dangerous.**

## **A NEW APPROACH: SECURITY CODE**

Security codes impose minimum standards governing locks and security precautions on doors, windows, and other potential points of illegal entry on all new and remodeled existing buildings. Some legal considerations that support state and local fire and safety regulations in building industry can exercise their delegated power to establish minimum standards of design, construction, and quality of materials used as security devices or for security precautions.

### **PURPOSE OF CODE**

The building security code is not intended to prevent a determined and knowledgeable thief from breaking into a building. The purpose of minimum standards derives from an understanding of the relationship between opportunity and criminal behavior and a realization of the ineffectiveness of traditional security devices. The provisions in code are intended to make illegal entry more difficult, thereby preventing opportunistic burglaries.

In order for a crime to take place, three elements must be present - desire, ability, and opportunity; furthermore, all three must be in existence at the same time. It is not sufficient for a person to have the ability and opportunity to commit a theft if the desire is not also present. Similarly, if the person has the desire and ability without the opportunity, no crime can occur. Thus, if it is our intention to reduce the occurrence of crime, we must remove one or more of these necessary elements.

At examining our traditional security devices we find

they fail to stand up to threats of crime and the burglars have capitalized on their weaknesses. First of all, consider the basic key-in-knob lock used on most exterior doors, especially new residential buildings. There are several basic weaknesses of this lock. The first lies in the fact that the locking cylinder is in the knob, and once the knob is twisted or broken off, the lock has been defeated.

Another weakness of the key-in-knob lock is the beveled spring loaded latch which projects into the strike at door jamb and holds the door closed. The most expensive spring latches have a maximum of 15mm throw, with the more common having 9 to 12mm throws. A screwdriver, pry bar, or tire iron wedged between the door and the jamb easily develops the leverage needed to overcome the short distance these latches extend.

Doors that open toward the outside generally have hinges mounted so that the hinge pins are exteriorly exposed. Removal of the hinge pins will allow the door to be opened or removed in most cases, even then a good locking device is used on the other side.

Aluminium-frame sliding doors and windows, especially the later, are coming in common use. Many of the sliding-type doors and windows have an appreciable amount of vertical freedom which enables the door or window to be lifted in and out of the guide track. This movement also permits manipulation of the sliding section into positions that can disengage the locking device.

## **REVIEW OF DESIGN**

Security can be addressed much more sensibly at the early stages of a development instead of as an afterthought.

Planners recognize the advantages of having law enforcement personnel become involved in the planning process and respond by including a police representative on their staff. Design and drawings should indicate a certain level of security and should be reviewed by the security agencies to determine such compliance.

## **MODEL CODE**

Governmental Agencies for Housing and public works and other agencies related to public welfare and safety should adopt a security ordinance as a guideline in achieving a certain level of security and social defence in building design. Presented here is a suggestive code which can be refined or modified into a model security code for multiple- dwelling buildings. Similar codes can be developed for villas, single family residences and other types of public works.

### **1 - EXTERIOR DOORS**

- A. Exterior doors and doors leading from garage areas into multiple dwelling buildings and doors leading into stairwells shall have self locking devices, allowing egress to the exterior of the building or into the garage area, or stairwell, but requiring a key to be used to gain access to the interior of the building from the outside or garage area or into the hallways from the stairwell.**
- B. Exterior doors and doors leading from garage into multiple dwelling buildings and doors leading into stairwells shall be equipped with self closing devices, if not already required by other regulations or codes.**

## **2 - GARAGE DOORS**

Whenever parking facilities are provided, either under or within the confines of the perimeter walls of any multiple dwelling, such facility shall be fully enclosed and provided with a locking device.

## **3 - SWING DOORS**

- A. All wood doors shall be of solid core construction with a minimum thickness of 45mm.**
- B. Swing doors to individual units shall have dead bolts with 25mm minimum throw and hardened steel inserts in addition to dead latches with 12mm minimum throw. The locks shall be so constructed that both dead bolt and door latch can be retracted by a single action of the inside door knob.**
- C. An interviewer or peephole shall be provided in each individual unit entrance door.**
- D. Door closers shall be provided on each individual entrance door.**
- E. Doors swinging out shall have non-removable hinge pins.**
- F. In-swinging exterior doors shall have rabbeted jambs.**
- G. Jambs for all doors shall be so constructed or protected so as to prevent violation of the function of the strike.**

## **4 - SLIDING DOORS**

(Which are less than one storey high above ground or are otherwise or are otherwise accessible from the outside).

- A. All single sliding doors shall have the movable section of the door slide on the inside of the fixed portion of the door.**

- B. Dead locks shall be provided on all single sliding doors. Mounting Screws for the lock case shall be inaccessible from the outside.**
- C. Double sliding doors must be locked at the meeting rail and meet the locking requirements of “B” above.**

## **5 - WINDOWS**

- A. Windows shall be so constructed that when the window is locked it cannot be lifted from the frame.**
- B. Large glass windows shall not be used within three meters of ground level.**

## **6 - HALL WAYS**

- A. In multiple dwellings, there shall be no hidden corners or dark dead ends in lobbies, halls and corridors.**
- B. Entrance lobbies and halls shall have a janitor’s office for continuous surveillance.**

## **7 - NUMBER OF DWELLINGS PER FLOOR**

**All multiple dwelling high rise buildings shall have a maximum six units per floor.**

## **8 - HEIGHT OF BUILDING**

**Multiple-dwelling buildings shall be limited to a maximum height of eight floors.**

## **9 - ELEVATORS**

**Each high rise multiple dwelling must have a minimum of two elevators with a possible addition of third elevator exclusively for unescorted women.**

## **10 - EXCEPTIONS**

No portion of this code shall supersede any local or state law or code dealing with the life-safety factors.

Enforcement of this ordinance shall be developed with the co-operation of the local fire authorities to avoid possible conflict with fire laws.

## **SECURITY LIGHTING SYSTEM AND HOW IT WORKS**

Surveillance and security lighting can be defined as illumination of sufficient quantity and adequate distribution so as to deter or permit detection of strangers as they approach or enter and circulate within the security sensitive area, and also to ensure the safety of residents as they approach, enter or circulate within the premises. Without an adequate exterior protective lighting system, all those plans already formulated for the creation of an adequate perimeter barrier and establishment of area security would be most ineffective during the hours of darkness.

Either of the following two systems or combination of both systems may be used to provide the necessary lighting. The first method is to illuminate the perimeter boundaries and approaches to the boundaries; the second method is to light the area and the structures within the perimeter barrier. If a security lighting system is to be effective, it must accomplish the undergiven purposes, and these provisions should be kept in mind during the entire analysis of the lighting system:

- 1 - The system should be designed to insure that the illumination is sufficient to discourage and deter entry.

- 2 - Should entry be accomplished, the intensity of illumination should be sufficient to make detection certain.
- 3 - Installation of individual lights should avoid throwing any glare in the eyes of security personnel or casting glaring lights into adjacent streets, highway traffic areas and neighboring communities.
- 4 - The system must be reliable, a failure of any single light should not have an intensely dark area in the building complex.
- 5 - The system must provide special lighting for points of ingress and egress on the perimeter.
- 6 - The system must provide means of convenient control and maintenance.
- 7 - All light poles and other related equipment must be located inside the perimeter, so that it is not accessible to damage.

In selecting light sources, luminaires, and systems to provide the recommended illumination of areas, and the brightness of surfaces involved in security, the general zones of concern can be designated as:

- Zone 1 - Exterior building surfaces, entrances, walls and roofs.
- Zone 2 - Exterior areas near buildings - parking lots, roads and walkways.
- Zone 3 - Exterior, intermediate areas, between the buildings and the area perimeter - storage areas, parking lots, roads, walks and open spaces.
- Zone 4 - Exterior perimeter areas - fence lines, roadway entrances, pedestrian entrances and open spaces.



## **LIGHTING CONTROLS**

- 1 - Automatic Controls:** These operate automatically by a photo electric cell installed on the lighting fixture itself, or in a central location with the control wired to several lights. The control is activated by the amount of light passing through the photoelectric cell. The system controlled by this device is automatically illuminated at darkness and extinguished at daylight.
- 2 - Timing Device:** This system is controlled by a timing device which automatically engages a switch at a given time of day. Care should be exercised when these devices are used to make sure necessary adjustments are made as daylight increases or decreases with the changing seasons of the year. Some of these devices are manufactured to automatically compensate for this difference.
- 3 - Manual Operation.** The entire system or a series of lights within the system is turned on or off by a member of the security force. Human error and omission are involved in manual operation, and may result in the lights not being illuminated or extinguished at the desired times.

## **LIGHTING REQUIREMENTS**

The following suggested levels of illumination, in minimum footcandles (fc) are based on the recommendation of Illuminating Engineering Society (IES) and American National Standard Practice for Protective Lighting. (For critical areas and special reasons these standards could be doubled for increased effectiveness).

### **Zone 1**

- ☆ 2.0 fc for building entrances and exterior walls, to a minimum height of 2.5 meters.
- ☆ 1.0 fc for roof surfaces.

### **Zone 2**

- ☆ 1.0 fc for parking lots
- ☆ 0.4 fc for roadways
- ☆ 0.2 fc for storage areas
- ☆ 0.2 fc for walkways

### **Zone 3**

- ☆ 1.0 fc for parking lots
- ☆ 0.4 fc for roadways
- ☆ 0.2 fc for walkways
- ☆ 0.05 fc for open areas

### **Zone 4**

- ☆ 2.0 fc for pedestrian entrances
- ☆ 1.0 fc for roadway entrances
- ☆ 0.2 fc for vertical planes above 1 meter from the ground
- ☆ 0.1 fc for fence line
- ☆ 0.05 fc for open areas
- ☆ 0.05 fc for boundary line (isolated fence or no fence)

## **TYPES OF LAMPS**

There are, primarily, four types of lamps or luminaires used in the security lighting system. Each type of lamp and

a general discussion of how each lamp operates appears below:

- 1 - Incandescent lamps. These are the same type of light bulbs used in ordinary table lamp and other household uses. These lamps illuminate instantly with the supply of power, but have much shorter life (750-2000 hours) compared to other types.
- 2 - Mercury vapor lamps. These produce a white light, which is caused by mercury and other gases acting with an electric current. They are rated upto a life span of 24,000 hours and wattage ranging upto 1,000 watts. They require a warm-up period initially to light up, and in the event of a momentary power interruption the lamp will not re-light immediately.
- 3 - Sodium vapor lamps. These lamps produce a high intensity of light of a yellow color and may be of value in a security lighting system in areas where frequent fog and hazy/dusty conditions occur. They are also rated upto a life span of 20,000 hours.
- 4 - Fluorescent lamps. These lamps respond to the ambient temperatures and so light output varies. Usual application of fluorescent lamps is limited to indoors only. In general they are rated with a life span in excess of 10,000 hours.

## **CASE STUDY**

This chapter discusses an example of a recently completed (but not occupied) project which employs a variety of physical features to provide natural security for their inhabitants. This project is chosen for two reasons:

- 1 - it is a current example;
- 2 - it depicts conscious decisions on the part of designers/owner to build environment which has an inherent capacity for assuring the residents of security.

A project's being current has additional significance, beyond its architectural character, of its being a response to the needs of meeting crime problems. Because of its size, complexity and scale it provides enough information and grounds for discussion and when fully occupied can be considered as a socio-cultural laboratory generating data and results suitable for future use.

It should be noted that no inferences are drawn here as to the social, cultural and architectural fitness of this project to the user groups. Instead, it is seen how this multiple dwelling complex responds to fight against social crimes to create defensible environment. Project is intended to read primarily as a direct statement of prototypical defensible space design.

Many other projects, in the Arab World, may be incorporating identical security features, but this complex was selected because of author's accessibility to it and its predominantly security-oriented features. Finally it should be kept in mind that the extent of the success of the illustrated project in inhibiting crime and improving security has not yet been fully realized. A full scale, scientific measurement of its success and failure, and the way in which the different components of design contribute to the defensibility of the project, will have to wait for the completion of other studies in coming years.

## **DAMMAM CRASH HOUSING PROJECT**

**OWNER: MINISTRY OF PUBLIC WORKS & HOUSING, SAUDI ARABIA**

**CONSULTANTS: Birch and Krogbee - Overseas, Denmark**

**CONTRACTOR: OGEM B.V., Holland**

### **THE SITE**

The site is located southeast of Dammam at the southern side of the Dammam-Alkhubar road with an approximate area of 350,000 square meters.

### **THE PROJECT**

The project consists of eight clusters, A,B,C,D,E,F,G which are grouped around a large central common area containing mosque, walkways and gardens (see cluster plan).

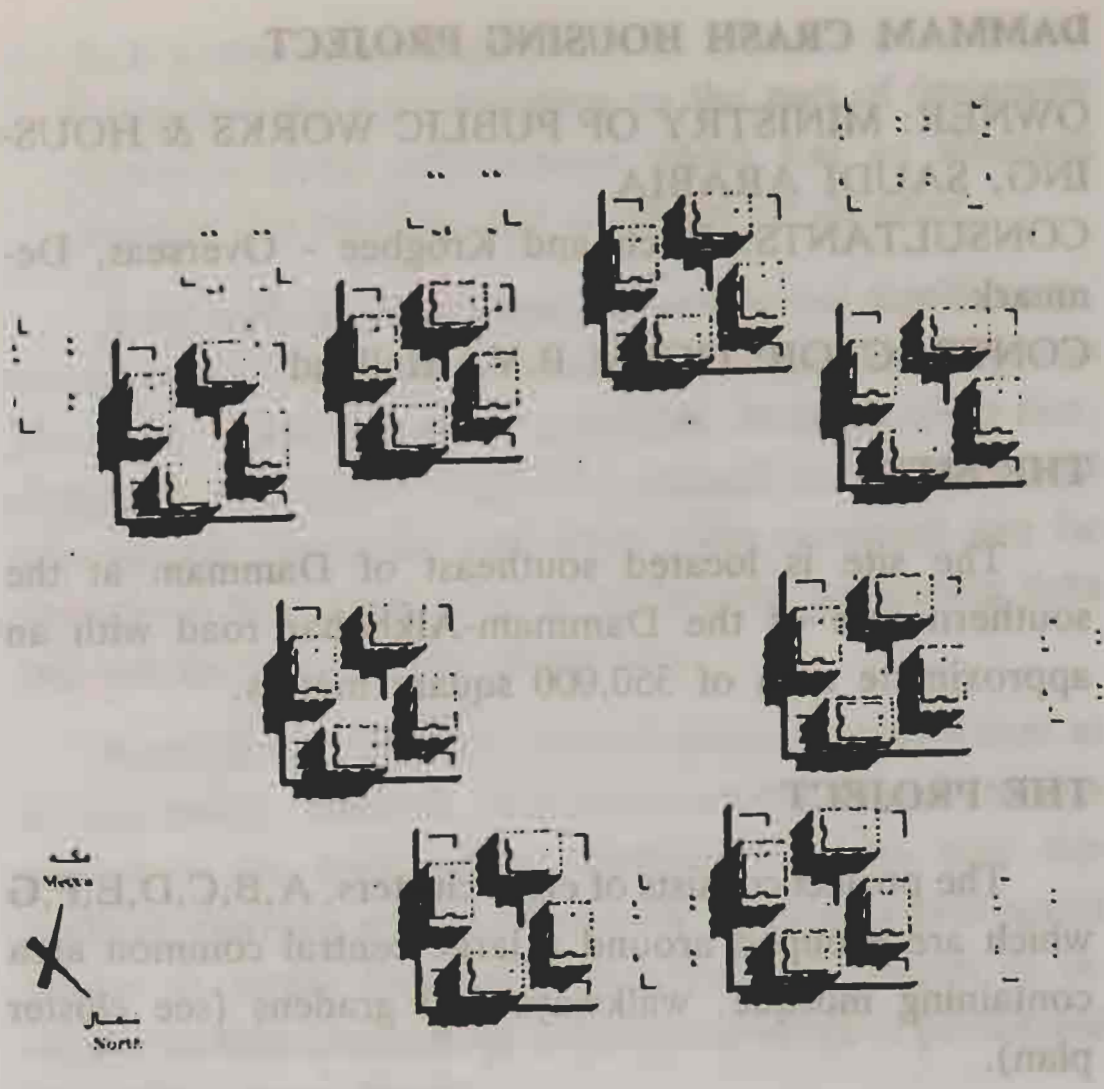

### CLUSTER PLAN

The construction of this High Rise Apartment Building (HIRAB) commenced in June 1977 and was completed in June 1979. During this period a labor force of approximately 2,500 persons was employed to construct these eight clusters, each of which contains four apartment towers. See a typical cross-section through the apartment tower below:

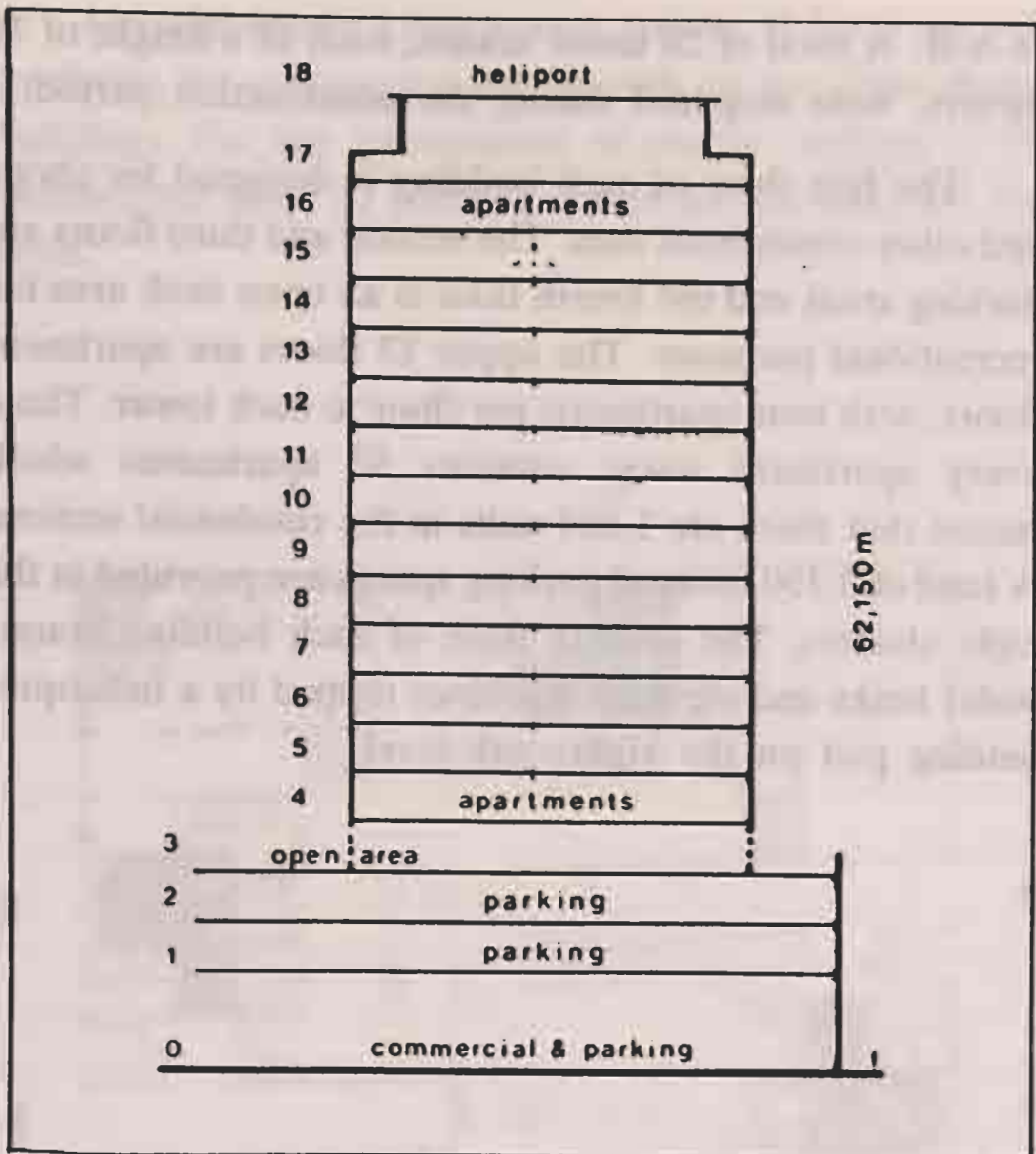

### TYPICAL CROSS-SECTION

Apart from the foundations and the subterranean emergency shelters, the project is entirely prefabricated. Approximately 170,000 prefabricated concrete elements were manufactured at 12-14 factories in Holland. In May 1978 a fleet of vessels were engaged in transporting concrete elements from the port of Rotterdam to the port of Dammam. At the building site the elements were stored at a stockyard just east of the site ready for erection, and the construction sequence of the clusters was C-D-E-F-G-

**H-A-B. A total of 20 tower cranes, each of a height of 75 meters, were required during the construction period.**

**The first floor of each building is designed for shops and other commercial uses. The second and third floors are parking areas and the fourth floor is an open deck area for recreational purposes. The upper 13 floors are apartment floors, with four apartments per floor to each tower. Thus, every apartment tower contains 52 apartments which means that there are 1,664 units in the residential section. A total of 3,150 covered parking spaces are provided in the eight clusters. The seventh floor of each building houses water tanks and elevator machines topped by a helicopter landing pad on the eighteenth level.**



Approximately 3,000 square meters of floor space is available for commercial use in each of the eight cluster buildings. For the convenience of people working in the commercial area, 61 parking spaces are provided on this level.

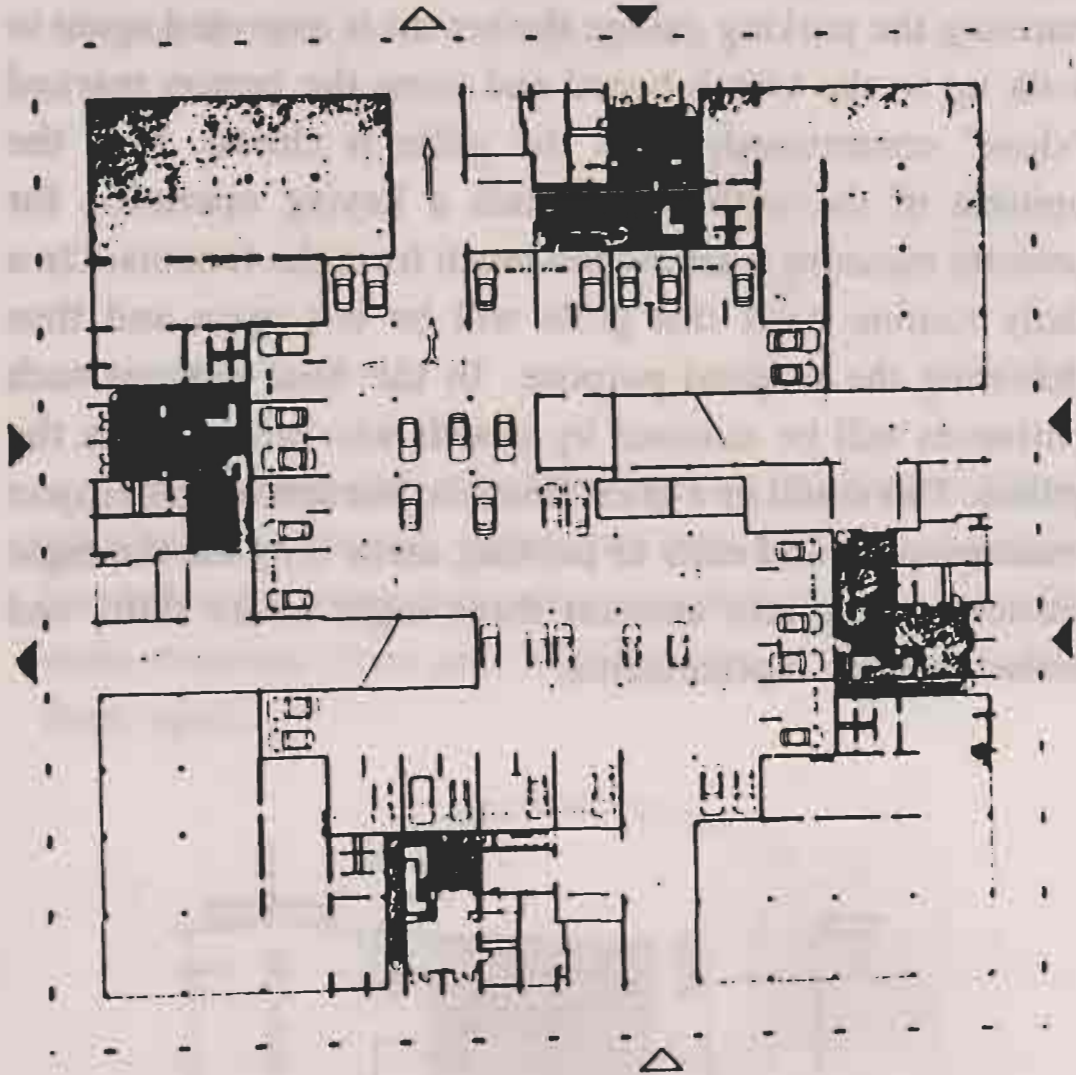

## **PARKING ENTRANCE**

The metal roll-up grille doors are operated by means of push buttons, located inside the parking entrance. To open the roll-up grille, the tenant must first enter the parking area by one of the side doors (picture below) which can be unlocked with any apartment key. To operate the grille door, the tenant will insert the apartment key in the key switch and press the push button marked "open". After entering the parking garage the tenant is expected again to walk up to the switch board and press the button marked "close" continuously until the grille is closed. It is the opinion of the author that such a keying operation for security measure is asking too much from the tenants. On a daily routine basis this grille will be left open and thus defeating the original purpose. In the final analysis such entrances will be manned by guards who will operate the grilles. This could be a great financial burden on the project maintenances and exits to parking areas only for the eight clusters taking into account three eight hours shifts and some standby replacements.

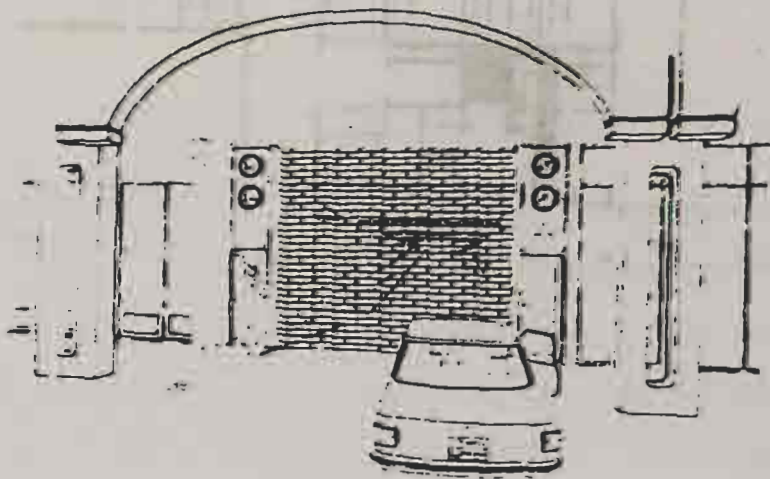

## **VISITORS ENTRANCE**

When visitors arrive they can contact the host tenant by pressing the relevant button on the push button panel, mounted outside the main entrance door (picture below). Each button is identified by an apartment number and the tenant's name, and when pressed, a bell will be activated in the tenant's apartment. After the tenant has answered, the visitor should identify by speaking clearly into the speaker located in the push button panel.

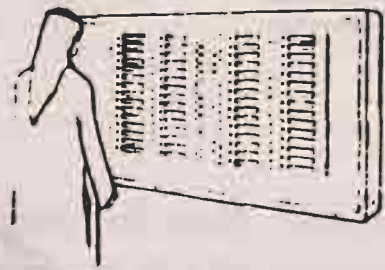

The tenant can admit the visitor to the building by pressing the "open" button on the communication box located in his apartment, thereby releasing the lock of the main entrance door and enabling the visitor to push the door open.

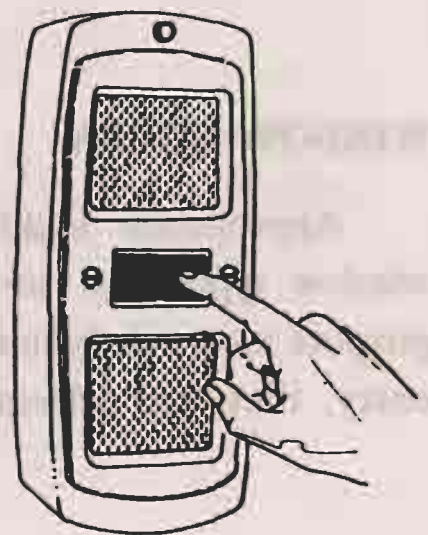



When visitors arrive they can contact the host tenant by pressing the relevant button on the push panel.

Casement

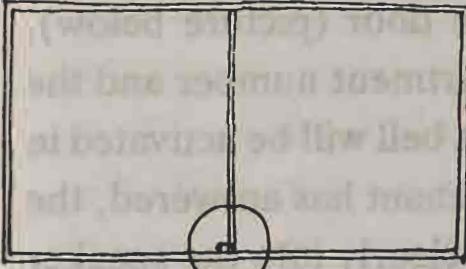

Sliding

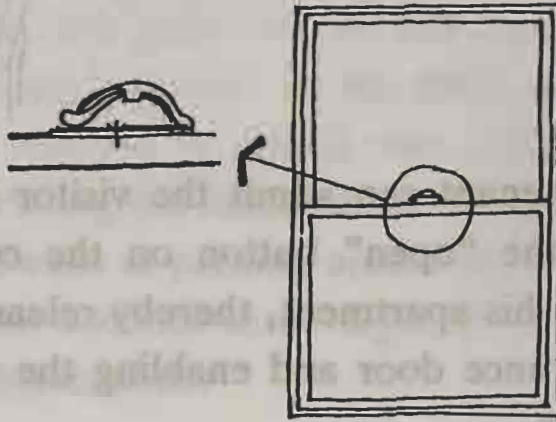
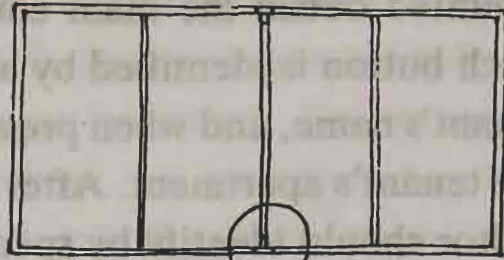

Double-hung

## WINDOW LOCKS

Appropriate locking devices are available for all window types and are a necessity. While their primary purpose is as a deterrent, rather than a physical obstacle to entry, they are extremely effective.

## **MAIN ENTRANCE**

To enter the main lobby, the entrance doors can be unlocked using any apartment key. All apartment keys are individual, but they all fit the main entrance door.

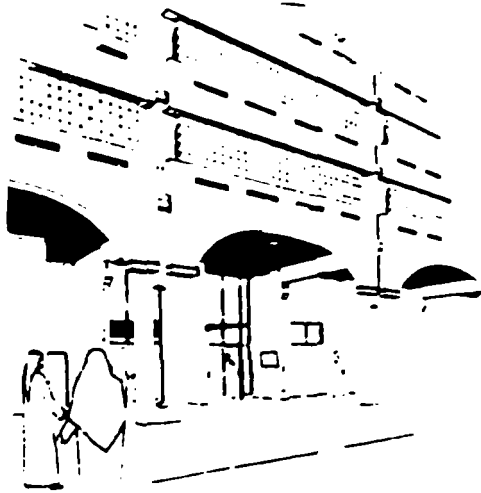

## **MAIN LOBBY**

It is located on the first floor of each residential building. In the background the two of the four elevators can be seen. An access from the main lobby also leads to the side area with two more elevators used only for ladies. All the four elevators serve all the floors along with a stairway. The janitor's office and the mail room are to the right in the picture.

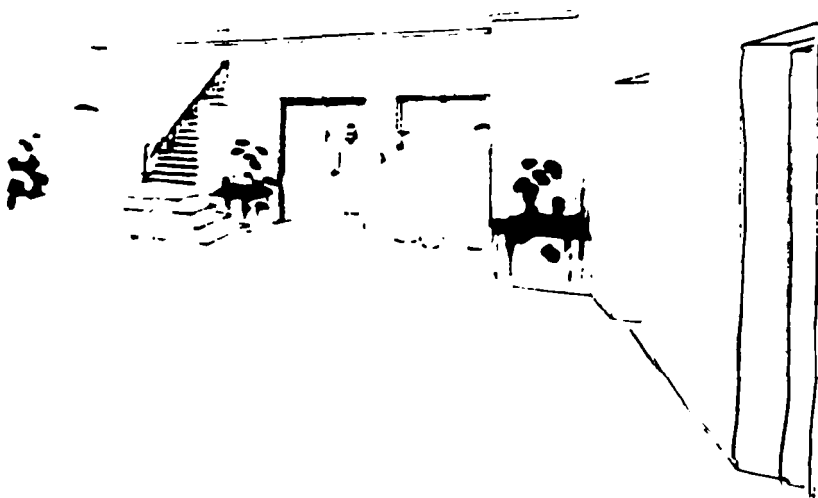

View of the main lobby

In each cluster building 332 covered parking places are provided for the tenants of the 208 apartments. Second floor has 166 spaces. Storage rooms (one for each apartment) are provided on this floor and the third floor. The number on the door of the storage room corresponds with the number of the relevant apartment. Only the relevant apartment key will fit the lock of the corresponding storage room door.

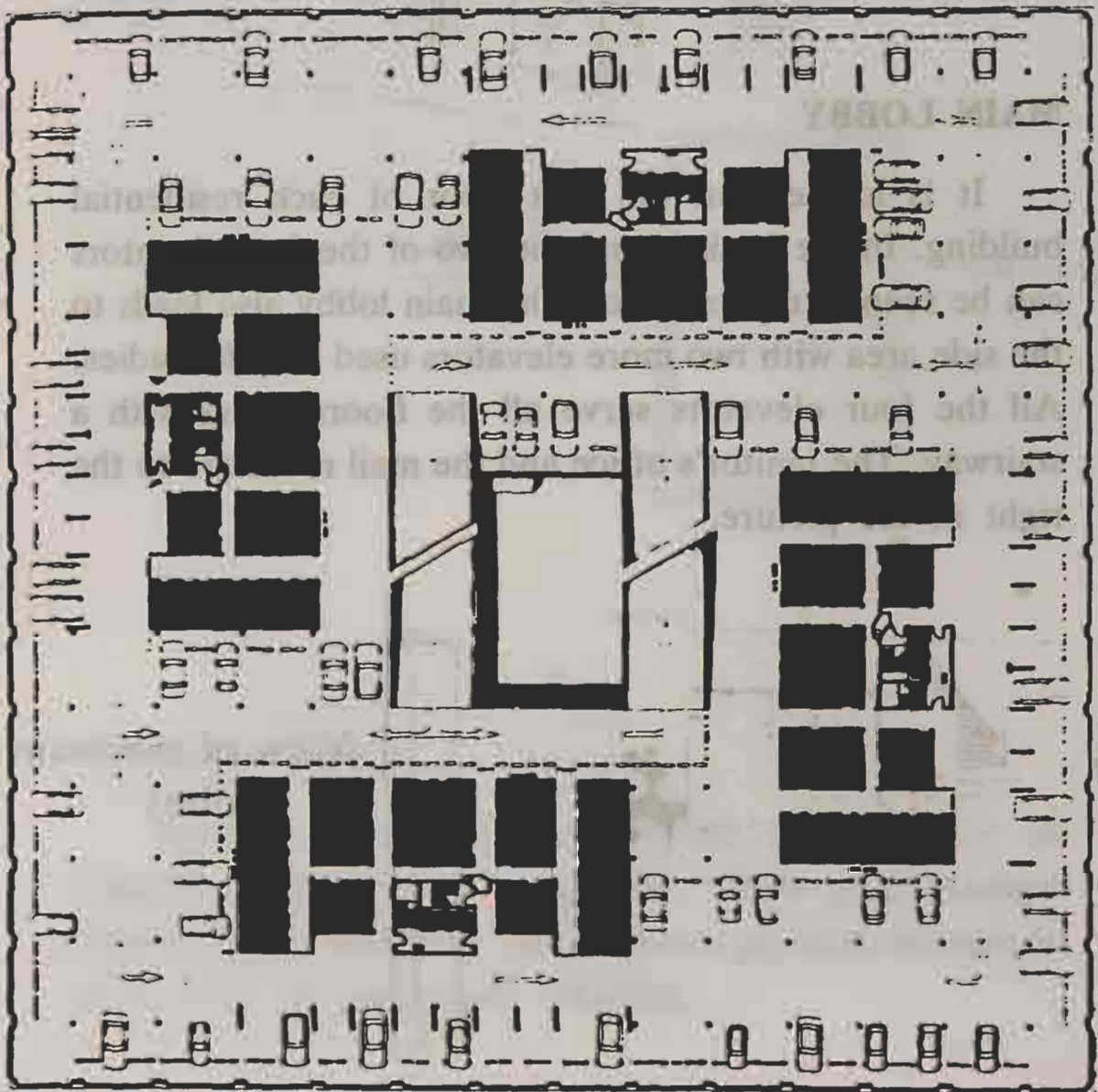

On the third floor another 106 parking spaces are reserved for tenants. Each apartment tower is connected directly with the parking floors by means of elevators and emergency and public stairs. Tenants of apartments numbered 27-52 will find their storage rooms on this level.

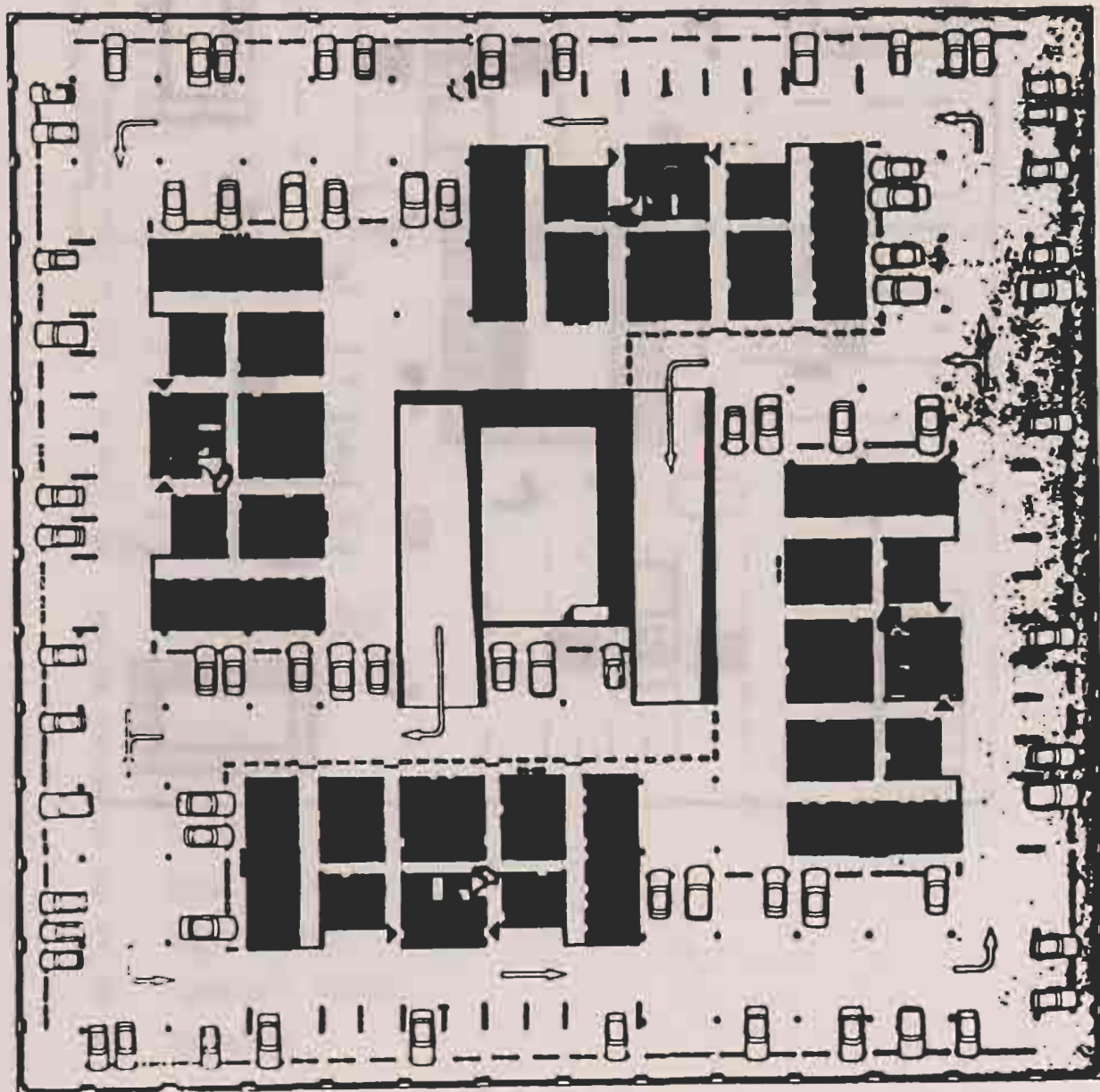



Each apartment is provided with access to the recreation area of this floor by means of elevators and main stairs.

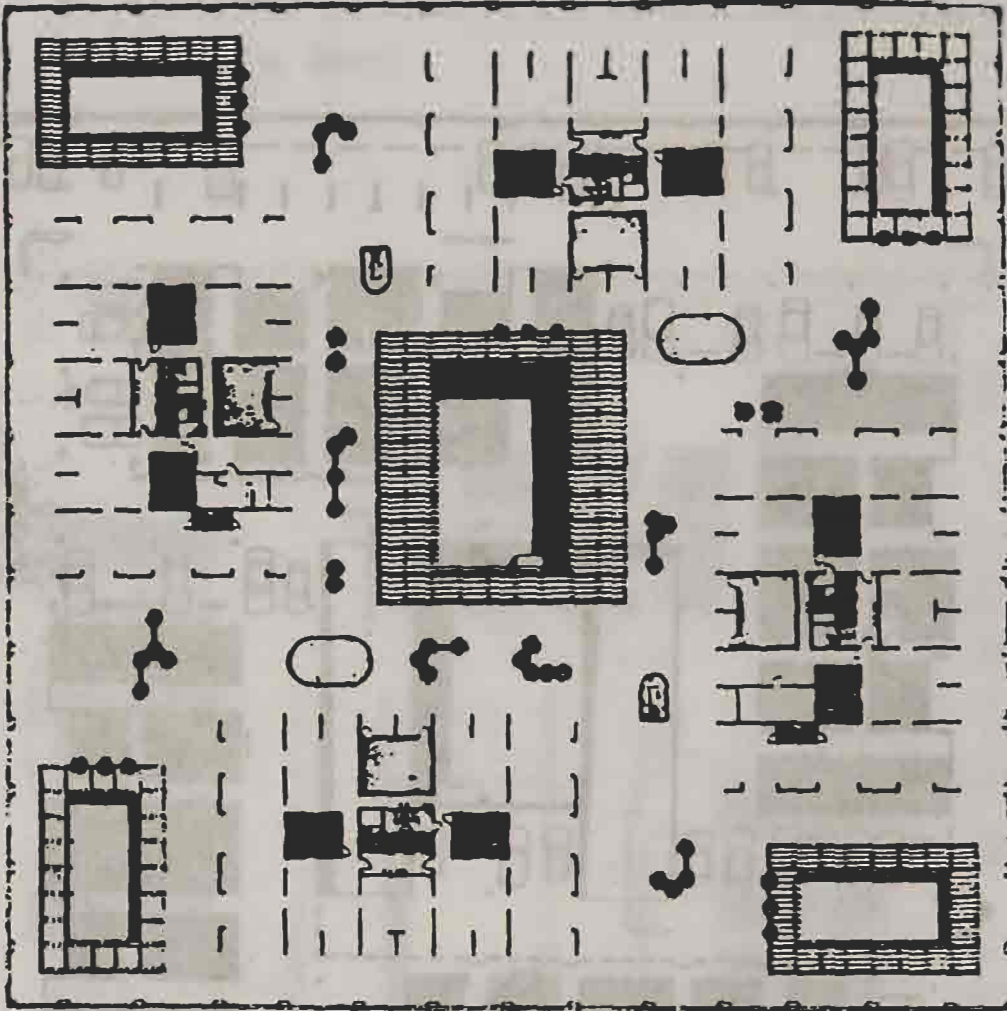



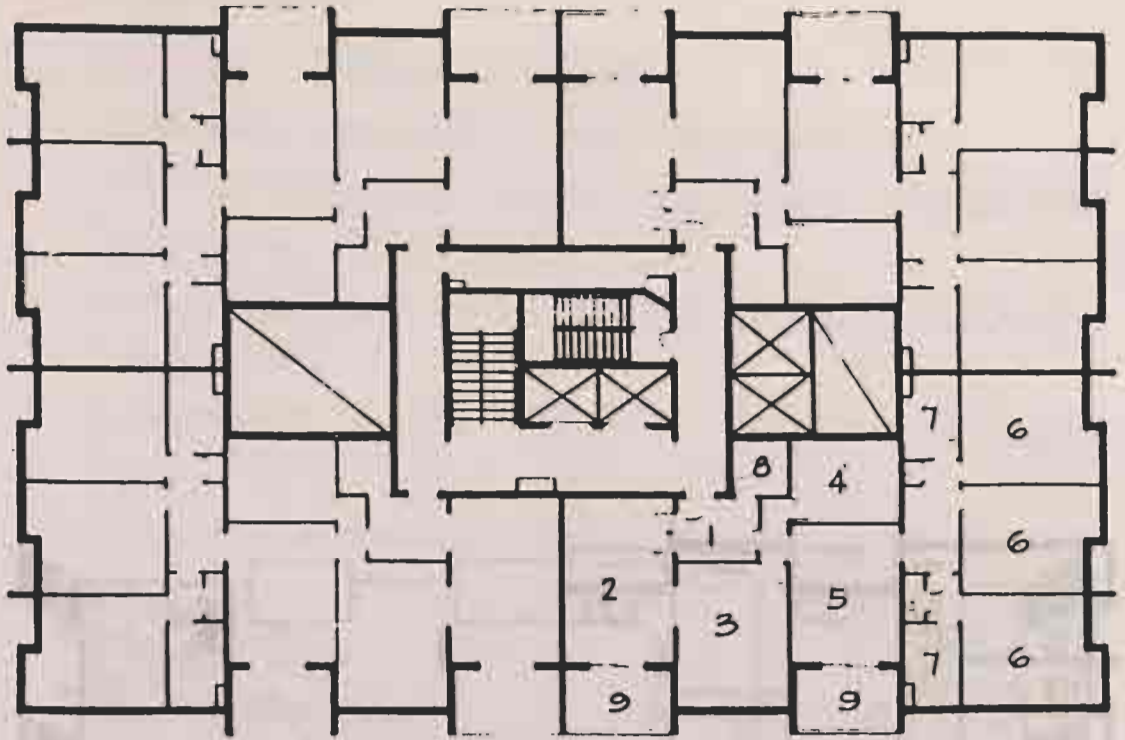

## LEGEND

- 1 - entrance hall
- 2 - majlis (visitors' sitting)
- 3 - dining
- 4 - kitchen
- 5 - family living
- 6 - bed room
- 7 - bath room
- 8 - visitor's toilet
- 9 - balcony

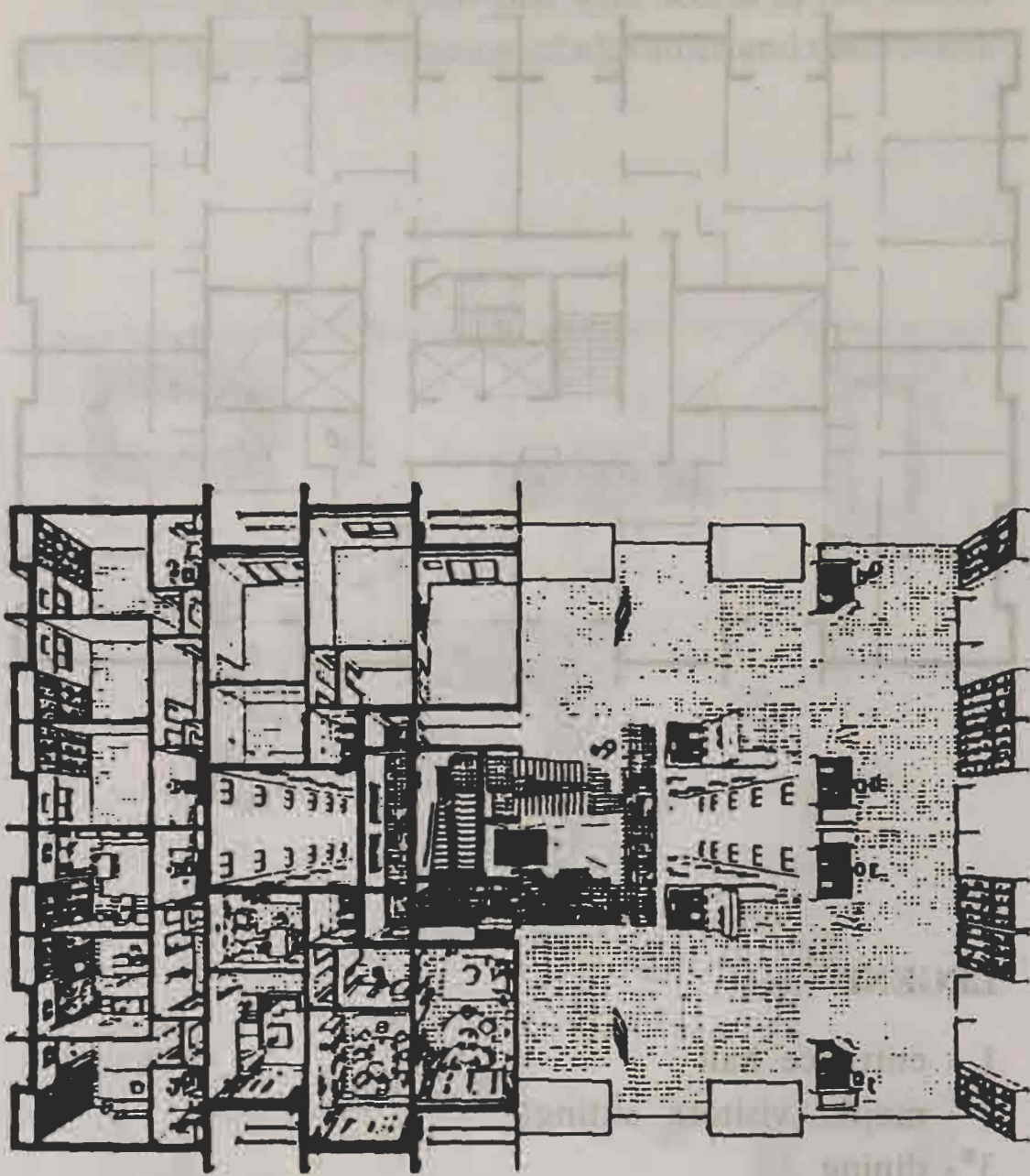

- 3 - dining
- 4 - kitchen
- 5 - family living
- 6 - bed room
- 7 - bath room
- 8 - visitor's toilet
- 9 - balcony

## **BIBLIOGRAPHY**

- 1 - Security - Walter M. Strobl  
Industrial Press INC., New York 1973.
- 2 - How to Completely Secure your home - Gerald Hall  
Tab Books, Philadelphia, 1978.
- 3 - Defensible Space - Oscar Newman Architectural Press -  
London 1972.
- 4 - Handbook of Building Security - Planning and Design,  
Peter S. Hope - editor, Mcgraw Hill Book CO., 1979.
- 5 - The effect of Islamic legislation on crime prevention in  
Saudi Arabia, Proceedings of the symposium held in  
Riyadh 9-13 October 1976 Ministry of Interior (CRIME  
PREVENTION RESEARCH CENTER), Kingdom of  
Saudi Arabia - Rome 1980.
- 6 - Kingdom of Saudi Arabia, Eastern Regional Plan,  
Ministry of Municipal and Rural Affairs - Department  
of Town Planning Affairs  
G. Candilis - Metra International Consultants, Decem-  
ber 1976.
- 7 - State Farm life, Casualty, General Insurance CO.  
F6-2355.
- 8 - AMF-Paragon Consumer Products Division, F-6101.
- 9 - Burglary Prevention Committee, Chicago, ILL. 60611.
- 10 - Kwikset - Division of Emhart Industries INC.
- 11 - Attorney General's Office, Governor's Council on  
Criminal Justice, Tallahassee, Florida 32304.
- 12 - Dammam Crash Housing Project Report, Ministry of  
Public Works & Housing and OGEM Consultants.

---

Printed by: The Security Press of The Publishing House of The Arab  
Security Studies and Training Center in Riyad. 1993



دار النشر  
مركز الدراسات والأبحاث  
الأمنية في الرياض



